



ERS SPONSORS SITE VISIT 2019

INTERNATIONAL
CONGRESS 2020

VIENNA Austria, 5-9 September



Professor Ernst Eber

ERS International Congress Chair

INTERNATIONAL CONGRESS 2020

VIENNA Austria, 5-9 September

WELCOME TO Vienna 2020



- In spite of the aftermaths of the crisis years, Vienna has maintained or even strengthened its status as a most attractive place to live and a top business location.
- The 2019 Mercer Quality of Living Index of global cities confirms that Vienna has remained the world's most livable city – for the tenth consecutive year.

Why Vienna is a great place to live:

- Reasonable living costs
- Safety
- Affordable transport system
- Clean and green
- Great links to other cities/destinations
- Great variety of things to do
- Big variety of childcare facilities
- Largest university city in German speaking countries



Austria & Medicine



The Medical University of Vienna celebrated its 10th anniversary as an independent university, separate from the University of Vienna, in 2014. So it is one of the youngest universities, but at the same time it can point to a tradition going back many centuries: From the Medical School of the Middle Ages to an ultra-modern research location.

- Earliest Evidence from the Middle Ages: Medical School founded in 1365
- The “Wiener (Medizinische) Schule” in the Imperial Capital
 - First “Wiener Schule” – Gerard van Swieten, Leopold von Auenbrugger
 - Second “Wiener Schule” – Carl von Rokitansky, Josef von Škoda, Ignaz Semmelweis, Theodor Billroth, Julius Wagner-Jauregg, Carl Landsteiner, Clemens von Pirquet ...
 - the birthplace of specialised medicine
- Cutting Edge Medicine in the 20th Century
- 1938: Turning Point in History
- 1945: Reconstruction of Society and Medicine
- 1994: The new Vienna General Hospital, now Europe’s largest University Hospital
- 2004: New Beginning – a modern research institution, employing a staff of 5,500 (3,600 academic; 1,600 medical doctors)



Green Vienna – Clean Air

Vienna offers green spaces, water, nature, diversity

- 280 imperial parks and gardens enrich the cityscape
- In spring, 400 species of rose bloom in the Volksgarten alone
- The nearby recreation areas of Prater, Vienna Woods and Lobau invite visitors to go on walks, day trips, hikes and bicycle tours (12 Oct 2019: Eliud Kipchoge ran a sub 2 hour marathon)
- Vienna has a total of 2,000 parks

Mobility requires human-scale and eco-compatible forms of transport. The City of Vienna is committed to prioritising public transport, and walking and cycling as the most environmentally friendly mobility modes. Vienna embodies a future-oriented urban mobility policy that is not only ecologically, but also economically and socially acceptable and hence sustainable.

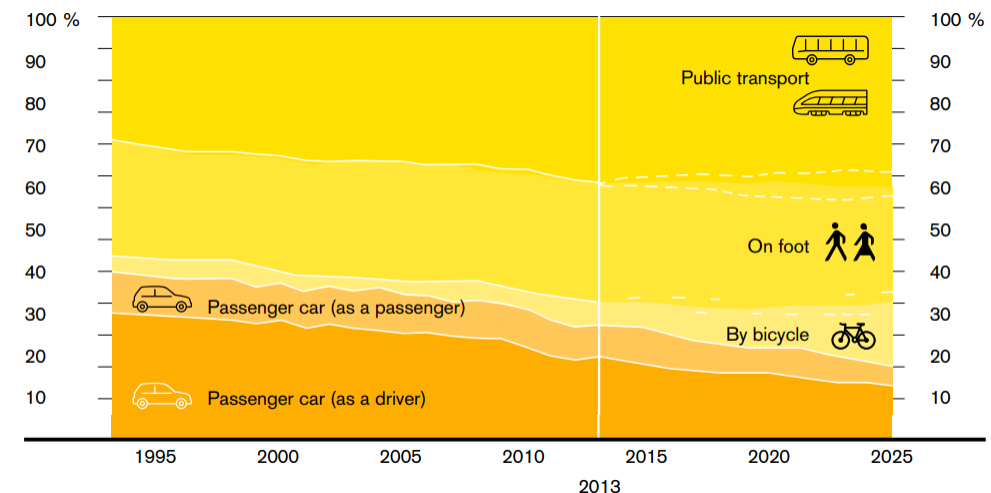

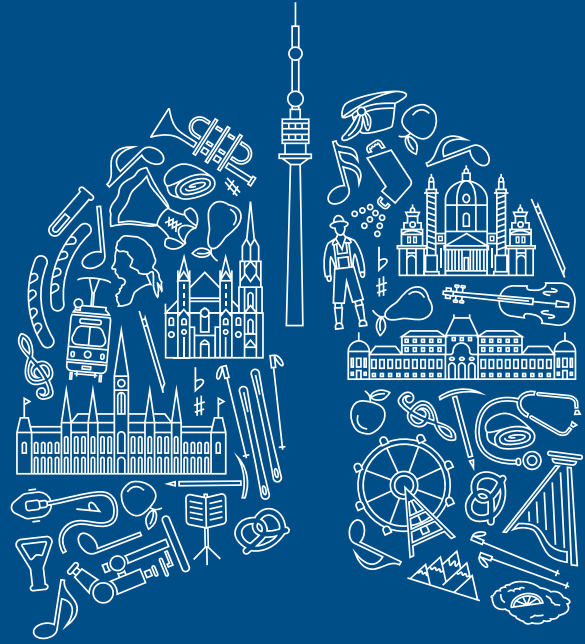

Professor Thierry Troosters

ERS President

INTERNATIONAL CONGRESS 2020

VIENNA Austria, 5-9 September

Presidential Cycle



MARC HUMBERT

Vice President
Declaration of Interests



ANITA SIMONDS

President Elect
Declaration of Interests



TOBIAS WELTE

Past President
Declaration of Interests



THIERRY TROOSTERS

President
Declaration of Interests



Mission and key objectives of presidency



ERS connects

Clinicians \approx Scientists \approx Industry \approx Technology
Countries \approx Europe \approx World
Experience the activities; be part of my Society



Integrated care

The best care is the one we do together
Initiative on non-pharmacologic interventions
Leuven 3-4 June 2020



Advocacy & Healthy lungs for life as a true 'Foundation'

Lung cancer screening
Vaping
Vaccination
Physical activity



Report from Madrid 2019

INTERNATIONAL CONGRESS 2020

VIENNA Austria, 5-9 September

Evolution of attendance

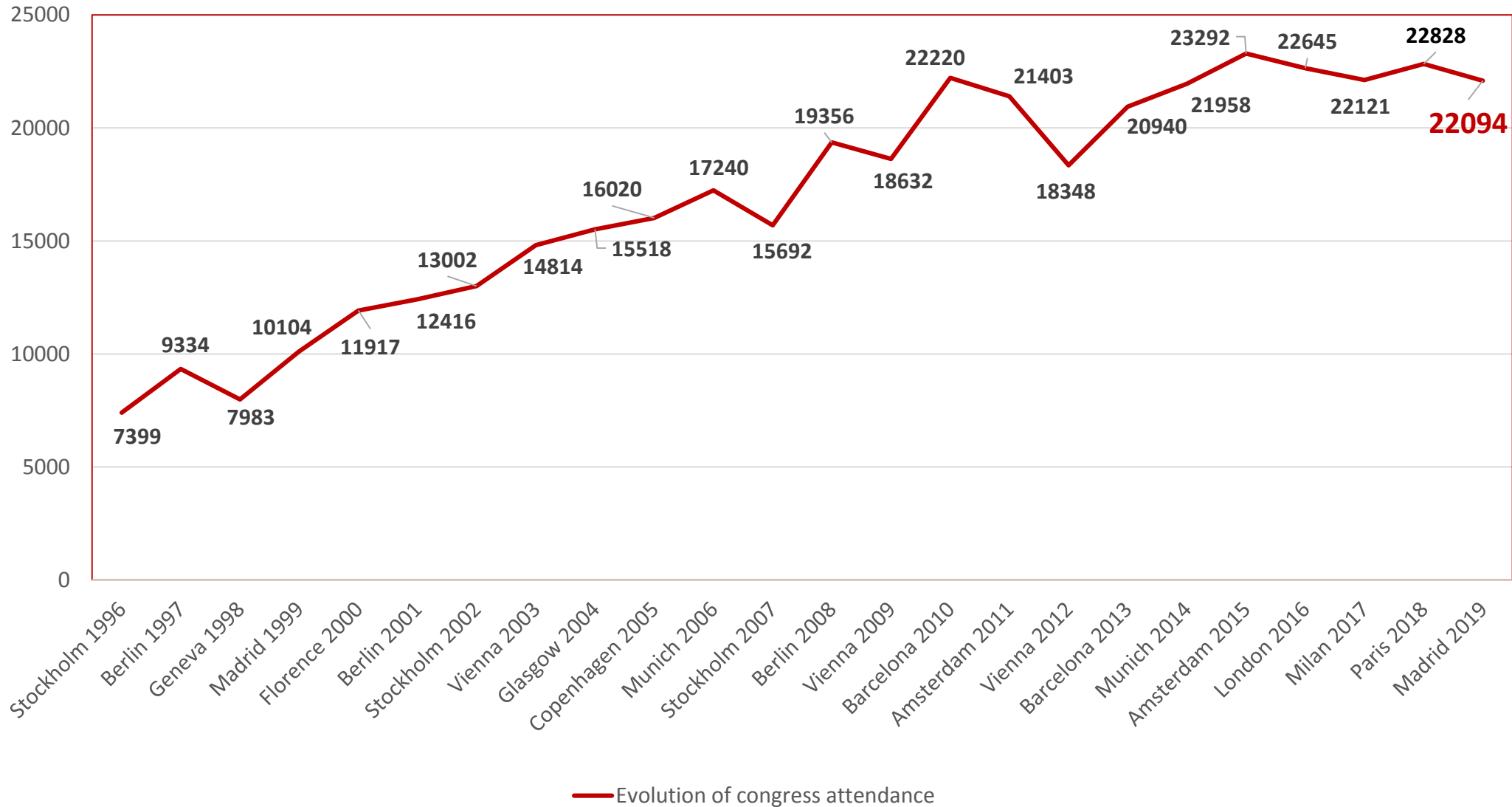

ERS Congress Madrid – Overview top 10 countries



Amsterdam 2015		London 2016		Milan 2017		Paris 2018		Madrid 2019	
Germany	1877	UK	3365	United Kingdom	2049	France	1921	United Kingdom	1823
UK	1738	France	1683	Italy	1722	United Kingdom	1690	France	1385
France	1372	Germany	1647	France	1655	Germany	1092	Spain	1266
Italy	1056	Italy	1145	Germany	1436	Italy	1014	Italy	1238
Netherland	997	Spain	1133	Spain	1102	Spain	994	United States	1089
Spain	893	USA	1008	United States	1017	United States	990	Germany	971
USA	851	Netherland	732	Netherlands	782	Netherlands	591	Switzerland	569
Switzerland	679	Switzerland	717	Switzerland	713	Switzerland	558	Netherland	564
Brazil	465	India	635	India	667	India	520	India	445
India	465	Turkey	450	Turkey	587	Turkey	448	Japan	445

Programme facts & figures



525 sessions
including 49 Sponsored sessions,
141 Thematic Poster sessions

5'617 Abstracts submitted
4'440 accepted

Over 1'000 faculty members

33 parallel rooms
from 40 to 1800 seats



Most popular sessions from the Congress programme

Session Title	Number of Views	Session Type
Severe asthma guidelines: update 2019	11832	Guidelines Session
Imaging Grand Round	9987	Grand Round
New recommendations and priorities for asthma management	9144	Hot Topic
Clinical Grand Round	8735	Grand Round
Interstitial lung diseases?	7226	Lungs on Fire
State of the art session: Airway disease	7123	Symposium
ALERT: Abstracts Leading to Evolution in Respiratory Medicine Trials: Interstitial lung diseases and pulmonary hypertension	7090	Clinical Trial Session
State of the art session: Respiratory infections	6268	Symposium
New clinical practice guidelines for chronic cough	6199	Guidelines Session
State of the art session: Interstitial lung diseases	6001	Symposium

17 September – 9 October

Congress programme highlights 2019



ALERT

Abstracts Leading to **E**volution in
Respiratory Medicine **T**rials

Case based sessions

Lungs on Fire
Challenging clinical cases
Grand Rounds

And much more

State-of-the Art sessions
Endoscopy sessions
Language sessions



Congress programme competition 2019

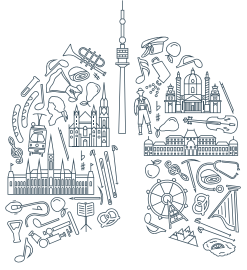

- 9 skill stations
- 1 CPR zone
- 1 smoothie stand
- 539 online MCQs

Championship session

- 4 team of Early Career members competing to become the European Champion in Respiratory Medicine
- 20 clinical case vignettes



495 participants logged in to the Game Zone platform



Working together to promote the programme



ERS

INDUSTRY



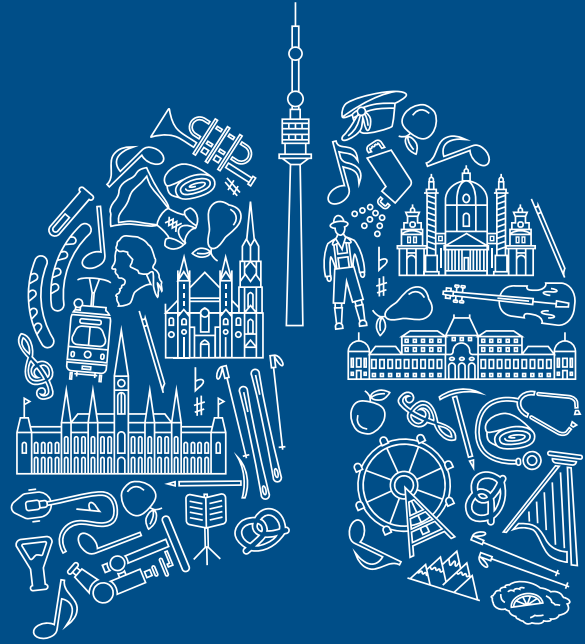

Professor Chris Brightling

ERS Science Council Chair

**INTERNATIONAL
CONGRESS 2020**

VIENNA Austria, 5-9 September

Vienna 2020 Theme and programme collaborations



Theme of the Vienna 2020 Congress

Respiratory diseases and their origins in early life

Collaborations

Scientific sister and national societies: cardiology, sleep, systems medicine, allergy, imaging and other disciplines.

Renowned scientific and medical journals: ERJ, JAMA, Lancet, NEJM, Thorax



Vienna 2020 – our focus





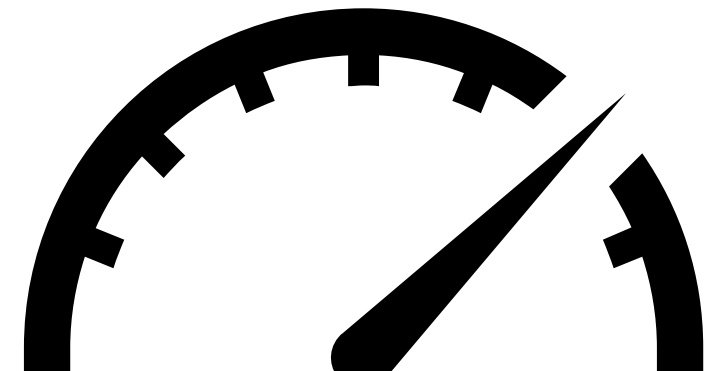



- Presentation of the **latest developments** in respiratory medicine and science
- Integration of **basic science, clinical research** and **guidelines**
- Alignment of **educational and scientific** topics
- Identification and application of **treatable traits** in asthma, COPD and ILD
- Implementation of **personalised medicine in real life**
- **Transition** of lung disease from childhood to adulthood



Congress programme



	SYMPOSIA	Guidelines, Year-in-review, Journal sessions, Hot topics, State-of-the art
	ABSTRACT	ALERT - Randomised clinical trials, Oral presentation, Poster discussion, Thematic poster
	CASES	Lungs on fire, Challenging clinical cases, Championship, Grand Rounds
	POSTGRADUATE & EXPERT	Post Graduate courses, Meet the experts
	SKILLS	Skills workshops, Training programmes, Game zone, CPR
	FACULTY/OFFICER DEVELOPMENT	Professional development, Officer excellence programme, Communication skills

New open space area



Format and programme still to be confirmed

Sessions to be allocated in this area:

- **Interactive sessions:** intimate interviews, pro/con debates, TED talks...
- **Short sessions**

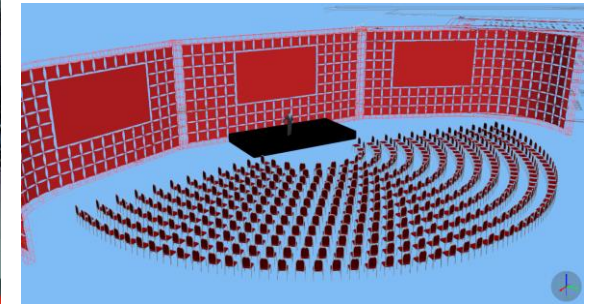

Clinical skills assessment



- Objective Structured Clinical Examination (OSCE) on thoracic ultrasound
- Up to 6 stations with expert assessors
- More information: www.ersnet.org/tus

New poster format to be piloted



Title

Authors

Intro



Methods

1. [Bar]
2. [Bar]
3. [Bar]
4. [Bar]

Results

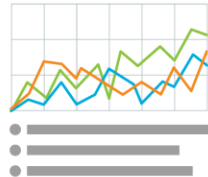

Discussion

More research is needed, but...

- [Bar]
- [Bar]
- [Bar]



Main finding goes here,
translated into **plain english**.
Emphasize the important
words.



Take a picture to
download the full paper

Extra Tables & Figures

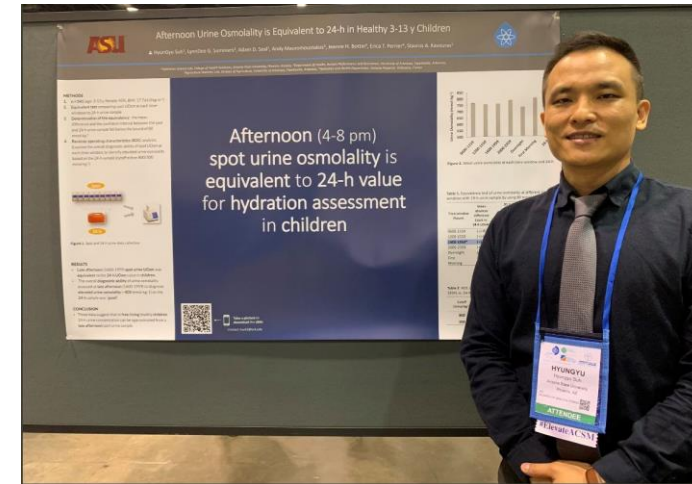

This new format will be suggested as a template and will be assessed by participants and chairs during Congress

Awards – Gold medals 2019



ERS Gold Medal in COPD

- Boehringer Ingelheim
- €50,000

Ian Adcock, UK



ERS Gold Medal in ILD

- Boehringer Ingelheim
- €50,000

Harold Collard, USA



ERS Gold Medal in Asthma

- AstraZeneca
- €50,000

John Fahy, USA



ERS Gold Medal in Lung Cancer

- ERS
- €50,000

Arnaud Scherpereel, France



Main awards 2019



Award	Sponsor	Amount
ERS Gold Medal in ILD	Boehringer Ingelheim	€50,000
ERS Gold Medal in COPD	Boehringer Ingelheim	€50,000
ERS Gold Medal in Asthma	AstraZeneca	€50,000
ERS Gold Medal in Lung Cancer	ERS	€50,000
ERS Romain Pauwels Research Award	GlaxoSmithKline	€50,000
ERS Award for Lifetime Achievement in PAH	Actelion	€10,000
ERS Research Award: Innovation in Non-Tuberculous Mycobacteria Science and Medicine	INSMED	€10,000
ERS Excellence Award for Research in Cystic Fibrosis	Vertex	€7,500

Abstracts travel grants 2019



Thanks to the following companies, 14 promising authors were financially supported to participate in the ERS International Congress

- Breas Medical
- Linde Medical
- Nox Medical
- POWERbreathe
- MGC Diagnostics
- The European Lung Foundation
- Olympus Europa Holding GmbH
- Vertex
- GlaxoSmithKline
- Mallinckrodt Pharmaceuticals



Important deadlines

End of December, 2019

Confirmation by sponsors for **abstracts grants funding**

Mid-December, 2019 - Mid-February, 2020

Online **abstract and cases submission** (including applications for sponsored Abstracts Travel Grants and ERS Sponsorship)

December, 2019 - April, 2020

Online **Hot Topics submission**

28 February, 2020

Online applications and nominations for **Gold Medals, Main Awards and Specific Grants**

1-31 May, 2020

Submission of **Late-Breaking Abstracts** (a submission fee is applied)

15 July, 2020

Last deadline for **Randomised Clinical Trials submission NEW**

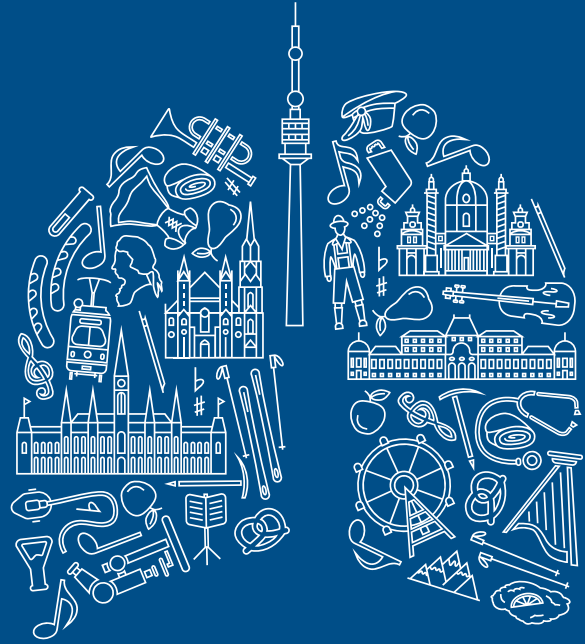

Patricia Foo

ERS Congress & Events Director

INTERNATIONAL CONGRESS 2020

VIENNA Austria, 5-9 September

Congress center layout



Messe Wien
Exhibition & Congress
Center

Taxi Stand
& Industry Bus

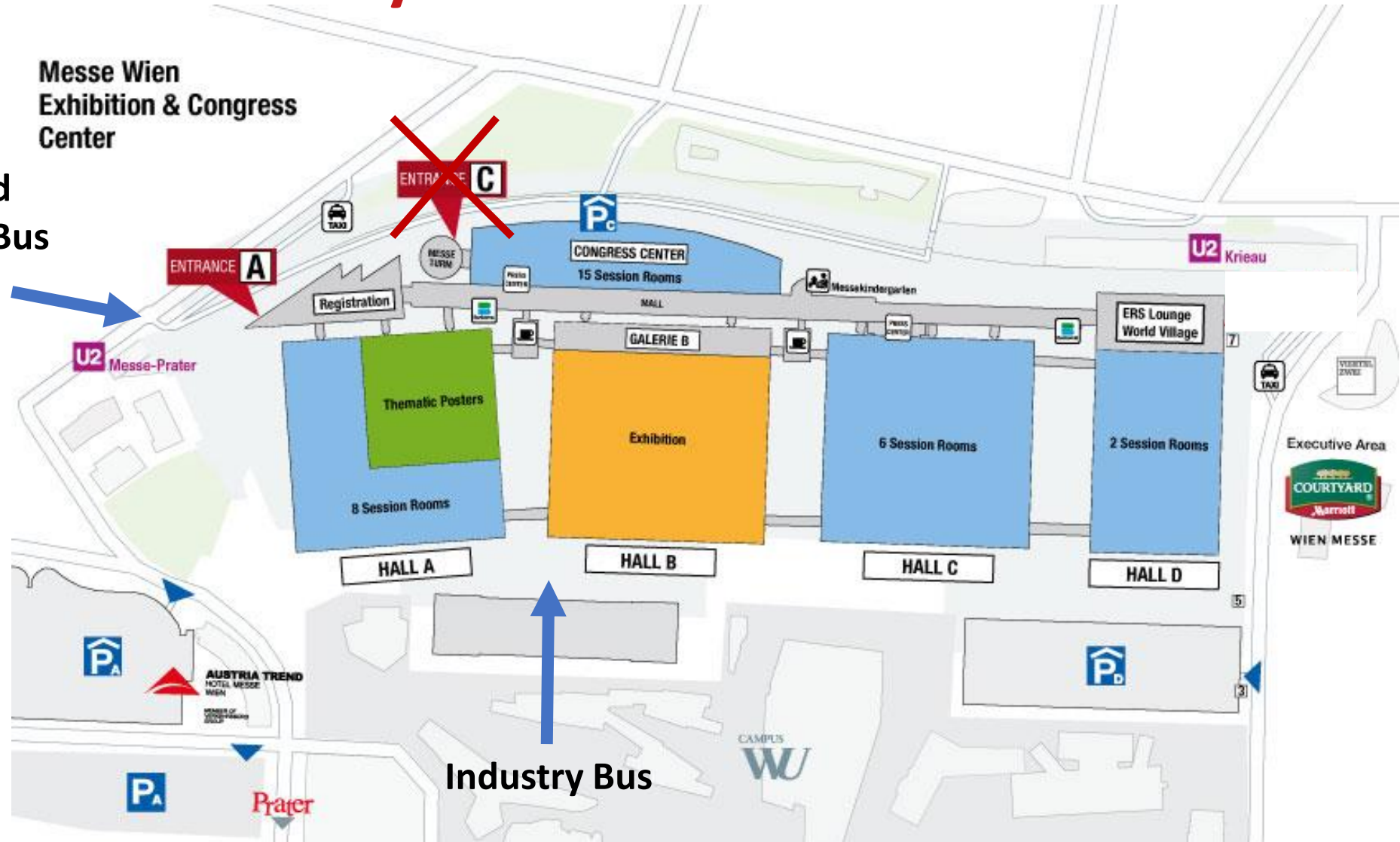

Industry Bus



Registration: important to know before you start

Please collect all participant information before you start with the online registration:

- Individual e-mail address of each participant
- Membership status and age
- Prescriber or non-prescriber

The e-mail address will help us to provide participants with:

- Pre-congress information
- Course materials
- Congress App
- CME Certificate

Help delegates, ERS and yourselves.

Group registrations



Group Registration

- > 5 participants
- Registration deadlines apply to groups & individual participants (names, payments, proofs and cancellation)

Group Registration Pick-Up

- By fixed appointments on Thursday, 03 September and Friday, 04 September 2020.
- Congrex Switzerland will contact all groups with a minimum of 10 participants to fix an appointment.

Please contact Congrex Switzerland for all information related to registration: ers2020registration@congrex.com

Industry badge vs Exhibition badge



Industry badge

- paid congress registration badge
- granted for hosting evening symposia, expert forums, practical workshops, early morning symposia
- access to session rooms and exhibition area



Exhibitor Badges

- for access to exhibition area and company's industry session only

Group registration



Registration Opens	07 April 2020
Early-Bird Deadline	07 July 2020, 24:00 CET
Cancellation Deadline	28 July 2020, 24:00 CET
No-Name/Name Change Deadline for Groups	05 August 2020, 24:00 CET
Standard Deadline	04 September 2020, 12:00 CET

Congrex



Congrex Switzerland is the official registration partner for the 2020 ERS International Congress.

How to reach Congrex:

- Contact: Silvano Schär, Rahel Wittlin
- Email address: ers2020registration@congrex.com
- Telephone: +41 61 686 77 77



Kristof Kemp

ERS Congress Industry Relation Manager

**INTERNATIONAL
CONGRESS 2020**

VIENNA Austria, 5-9 September

Opportunities at Congress



ERS
INTERNATIONAL CONGRESS 2020
VIENNA AUSTRIA, 5-9 September

Q search...

Home About ERS 2019 Practical information Registration Programme Funding and awards Industry Contact

Home - Industry

Site Visit Statistics Exhibition Industry Evening Symposia

Industry Mini-Symposia Industry Expert Forums Industry Early Morning Symposia Industry Practical Workshops

Advertising Sponsorship Press Activities Virtual Congress

Meeting Rooms Partners & Suppliers ERS Contacts

TAKING A RISK ASSESSMENT-BASED APPROACH IN PAH

SUNDAY, 29 SEPTEMBER 2019
17:15 - 19:15

ROOM N103
HALL NCC
1ST FLOOR

ACTELION

VISIT THE MEDICAL INFORMATION BOOTH H-02

New website is now online
Order forms are available

WWW.ERSCONGRESS.ORG

Exhibition 2019



Number of Exhibitors: 166
Pulmonary Pavilion: 9
Total: 175



Exhibition size (net sqm)

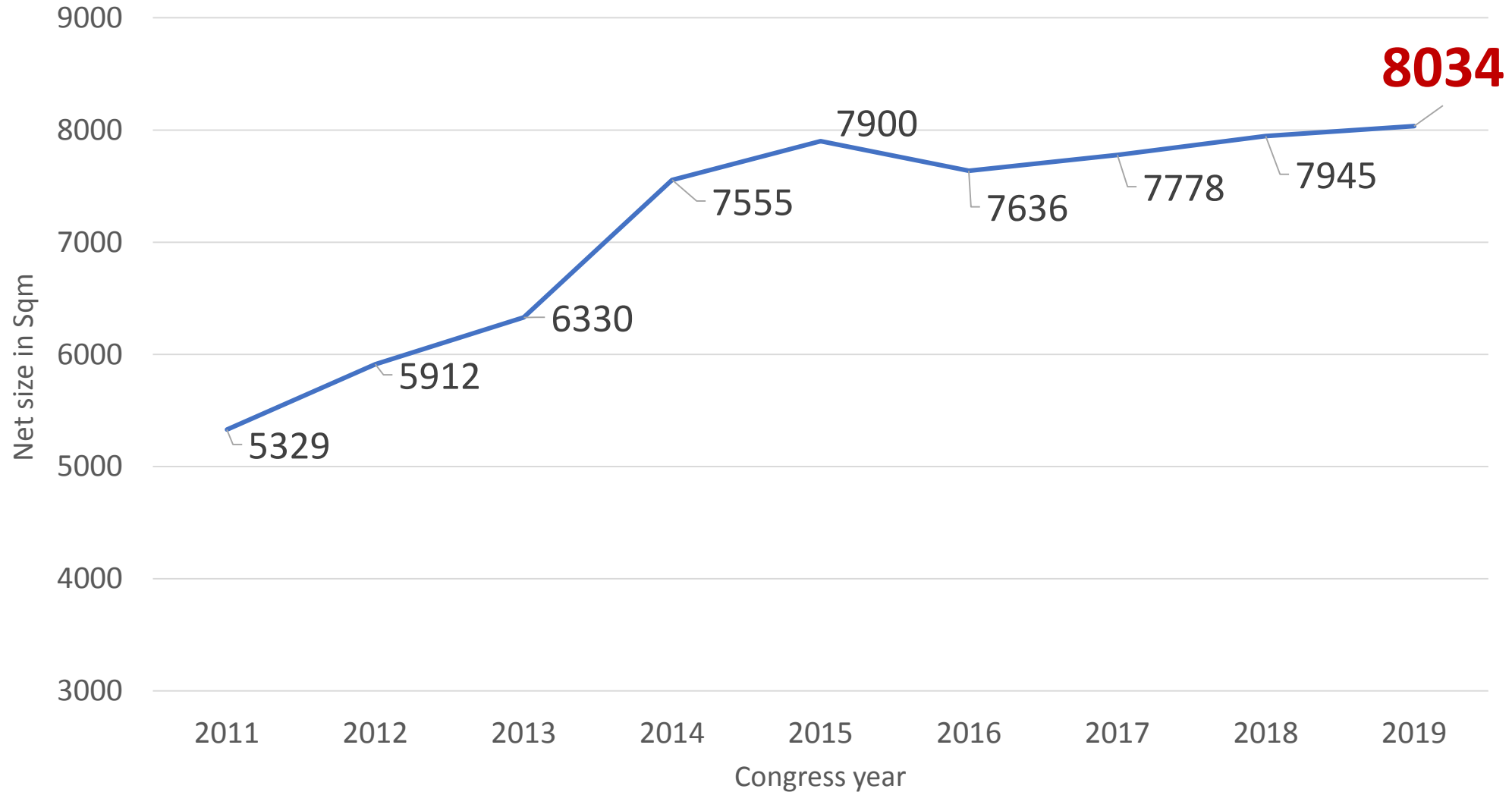

Exhibition layout

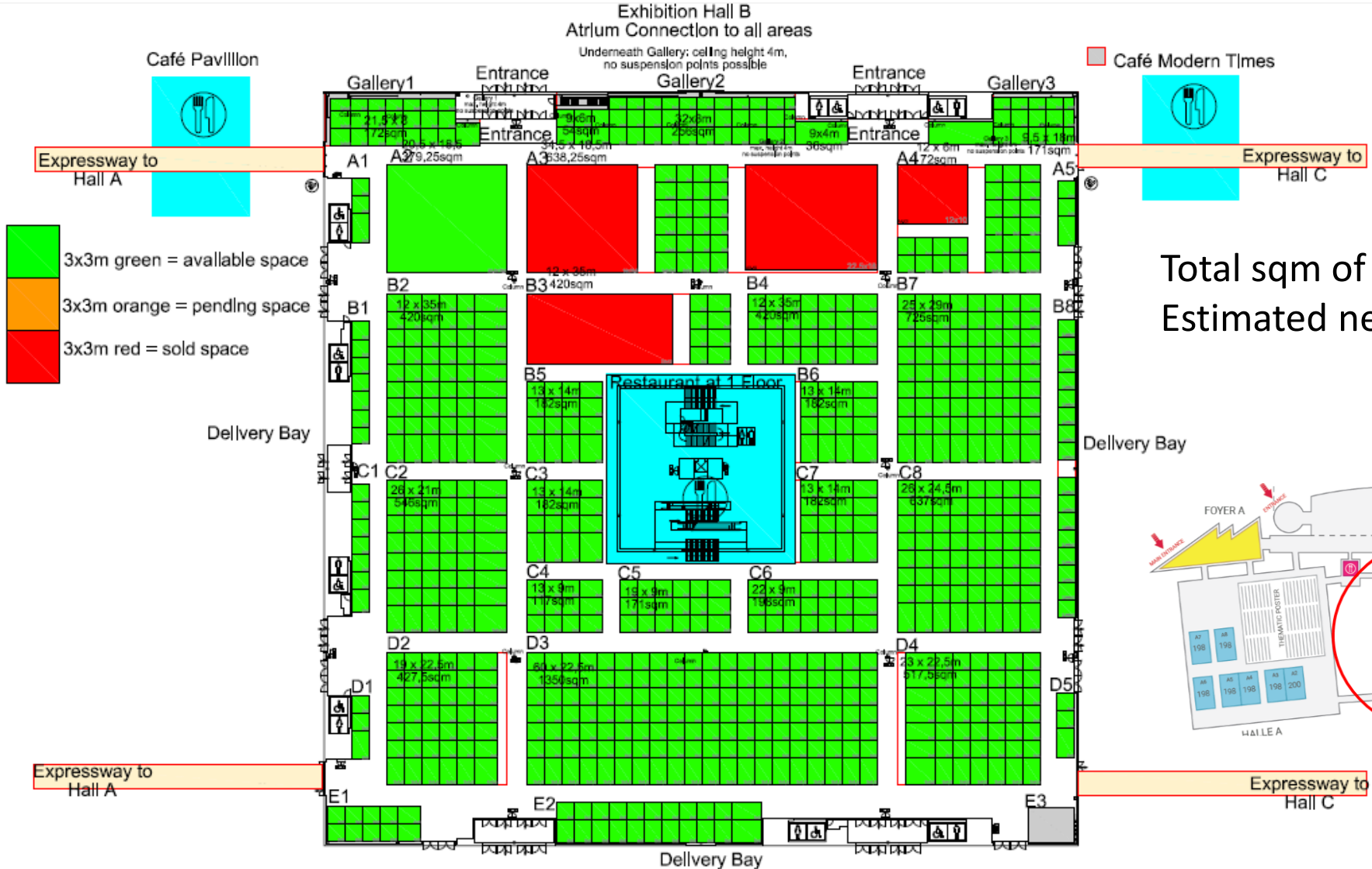

Total sqm of Hall B: **14'000 sqm**
Estimated net sqm: **7'950 sqm**

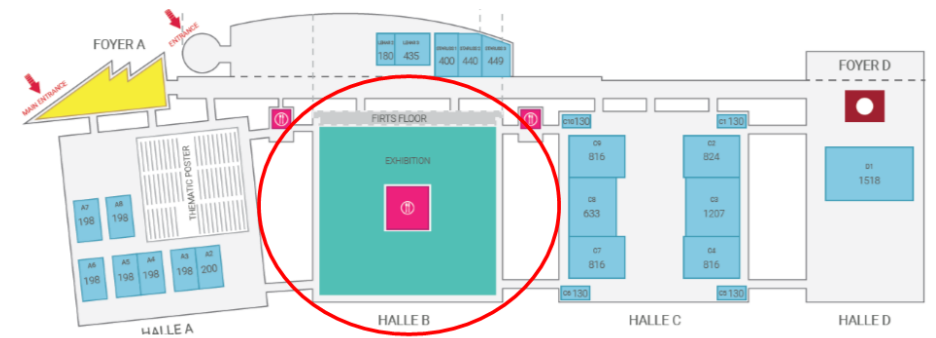

Lunchtime sessions on your stand



Available to:

Companies hosting an Industry session or with a stand of +100sqm

Schedule:

Sunday, Monday, Tuesday

12:45 – 14:45



It is the responsibility of the host company to ensure that the audience does not block the walkways of the Exhibition

Exhibition process



- Applications
- Allocation
- Contracting
- Stand approval
- Invoicing



- Pre-Congress support
- Onsite technical support
- Industry meeting rooms
- Exhibitors registrations

Industry practical workshops



13.15 – 14.30

Sunday, Monday, Tuesday

200 seats (4 rooms)	Theatre Style
60 seats (4 rooms)	Standing

Application subject to approval



Industry symposia options



Industry Evening Symposia

Industry Mini-Symposia

Industry Morning Symposia

Industry Expert Forum (Tuesday only)

Practical Workshops



New industry lunch session

Dates: Sunday & Monday
Availability: 2 sessions per day
Time Frame: 13.00 to 14.15
Logistics: 15 minutes set-up
15 minutes dismantling
Only light set-up
Room Size: 750/800 seats
Option: Catering allowed



Conditions: *Available to companies organising at least 1 Evening Symposia*

Price: EUR 100'000.-

Sponsorship items (Madrid successes)





Sponsorship opportunities in Vienna



- New opportunities in HALL B (Exhibition hall).
- Escalators
- Central Elevated F&B Area (Branding)
- Railings in the restaurant etc.

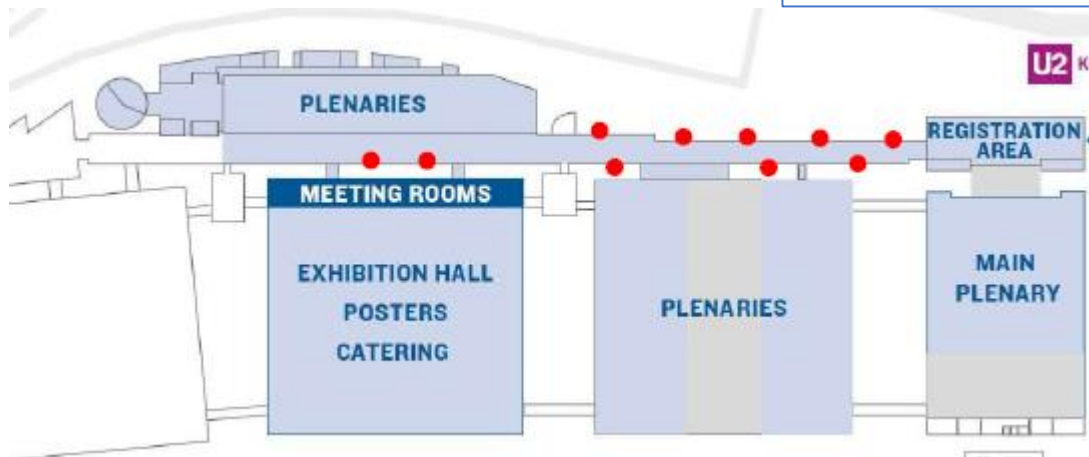
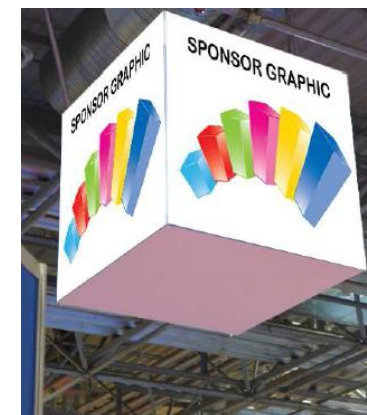
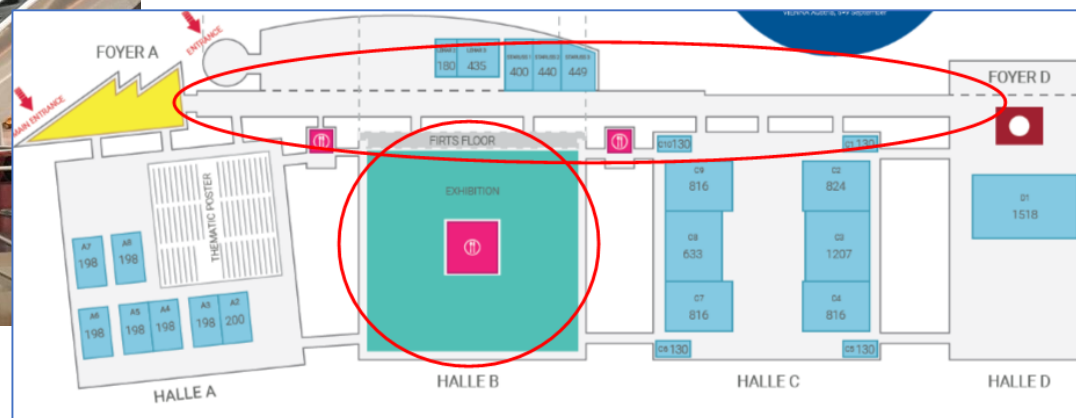

Advertising opportunities



Industry evening symposium

Integrating Type 2 Biologics in the Management of Uncontrolled Severe Asthma: The Importance of Lung Function in Disease Control

Monday, September 30, 2019
17:15–19:15, N103

Visit the Sanofi Genzyme and Regeneron Pharmaceuticals booth (M.01) to learn more about type 2 inflammation and uncontrolled severe asthma

[Click here for further details on the symposium](#)



This program is hosted by Sanofi Genzyme and Regeneron Pharmaceuticals
© 2019 Sanofi Genzyme and Regeneron Pharmaceuticals, Inc.
All Rights Reserved.
SAGLB-AST.19.06.0753n — August 2019



Web banner

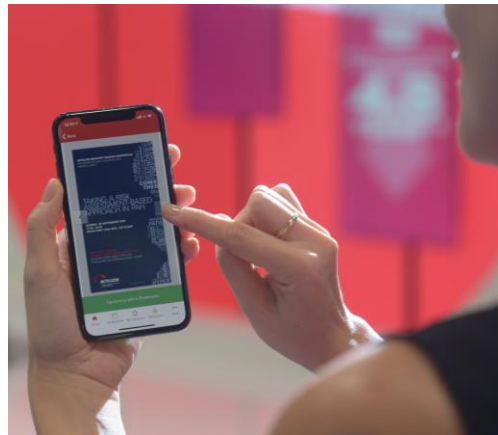

E-insert in ERS Congress App

Bechtel
Advances in COPD and ILD
Join our three evening symposia!
RespiratoryXchange

Bechtel
Advances in COPD and ILD
Join our three evening symposia!
RespiratoryXchange

Bechtel
Advances in COPD and ILD
Join our three evening symposia!
RespiratoryXchange

Bechtel
Advances in COPD and ILD
Join our three evening symposia!
RespiratoryXchange

Bechtel
Advances in COPD and ILD
Join our three evening symposia!
RespiratoryXchange

Bechtel
Advances in COPD and ILD
Join our three evening symposia!
RespiratoryXchange

Bechtel
Advances in COPD and ILD
Join our three evening symposia!
RespiratoryXchange

Bechtel
Advances in COPD and ILD
Join our three evening symposia!
RespiratoryXchange

Bechtel
Advances in COPD and ILD
Join our three evening symposia!
RespiratoryXchange

Thumbnail in emailing



Plasma Screens in exhibition Hall: New format for 2020



External Advertising

ERS Congress app

App Activations: **10,856**

Session views: **779,629** - This includes all sessions (private, industry, educational...)

Visits to online posters: **56,901**





App – Industry sessions search statistics

TOP 10 viewed industry sessions

Session Title	Number of Views
New Horizons in The Treatment of Pulmonary Fibrosis	3608
Personalised medicine in COPD: Matching the patient needs with the right care	3117
Beyond the clinical trial: managing severe eosinophilic asthma in practice	2938
ABCD in COPD	2577
The journey towards personalized medicine in asthma: where are we now?	2460
A New Era of Asthma Management: Anti-Inflammatory Reliever as the Foundation of Care?	2406
Are we doing too little too late in COPD management?	2255
Joint ERS/Industry session: Time to be smarter about inhaler usage	2206
Introducing Dupilumab for Adolescents and Adults With Uncontrolled Severe Asthma With Type 2 Inflammation	2205
Chronic Cough and Refractory Chronic Cough	2122



Live@ERS & ERS Congress Replay

8,634 unique users to the Live@ERS / ERS Congress Replay

136,152 interactions with the platform

The screenshot displays the ERS Congress Replay website interface. At the top, there is a navigation bar with the ERS logo, a search bar, and buttons for 'PROGRAMME', 'MY CONTENT', and 'LOGOUT'. Below the navigation bar, there is a search section with a search bar and a search icon. The search results are filtered by content type, with 'PRESENTATIONS / ALL' selected. There are also filters for disease areas and by day. A 'RESET SEARCH' button is visible. The search results show 2881 results, sorted by 'Views (Most viewed)'. The first result is a session by Juan Carlos Cardet titled 'Clinical approach to very severe asthma and changes from the previous ERS-ATS task force', with a 'View Webcast' button.

Stats: from 29 September until 16 October



Virtual Congress reach

Global reach outside Spain: 105 countries

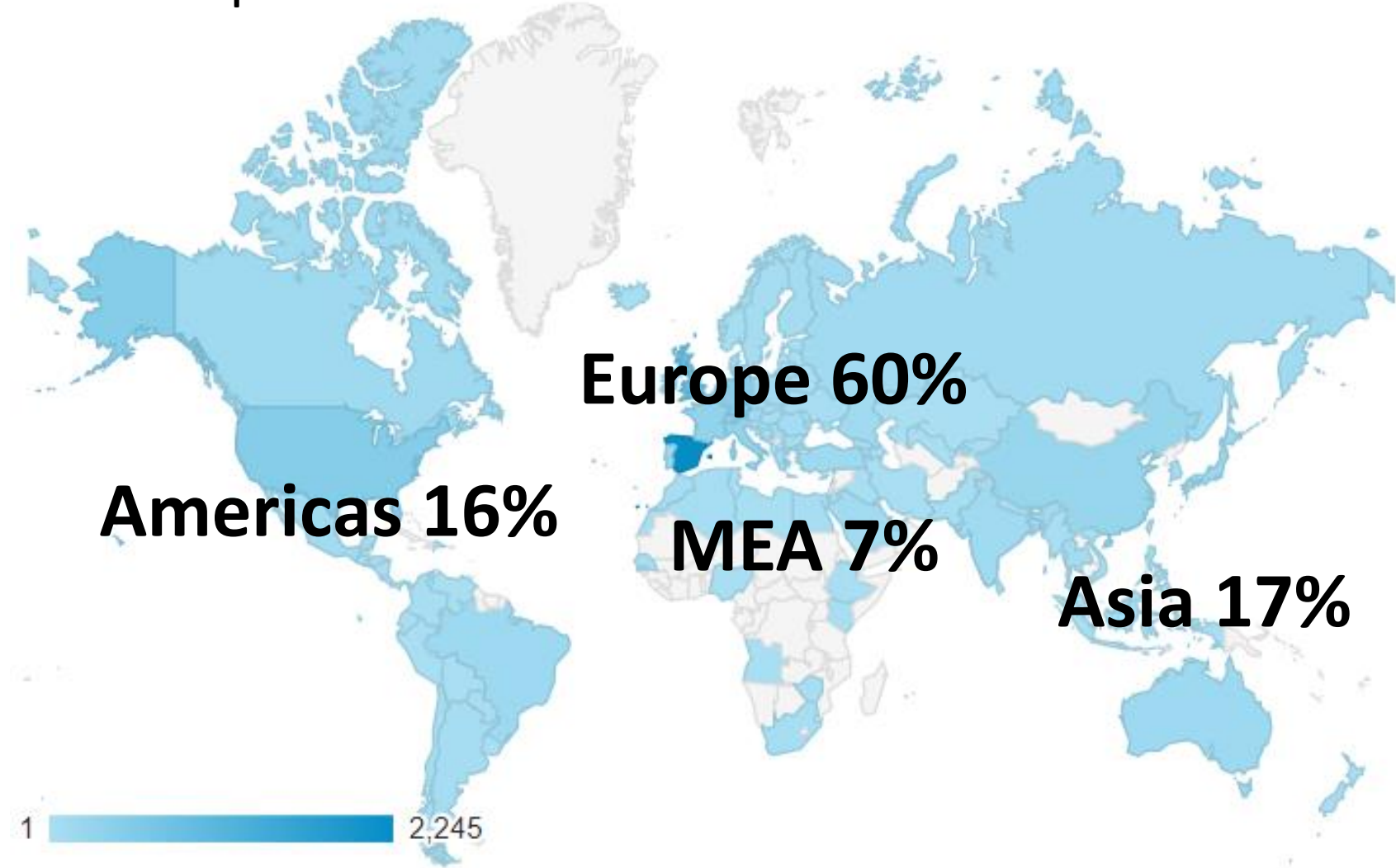



Other upcoming global ERS activities



ERS Respiratory Updates

8 November 2019

Amsterdam



ERS Satellites 2020

20-21 February 2020

Bucharest, Bruxelles, Hamburg & Rome

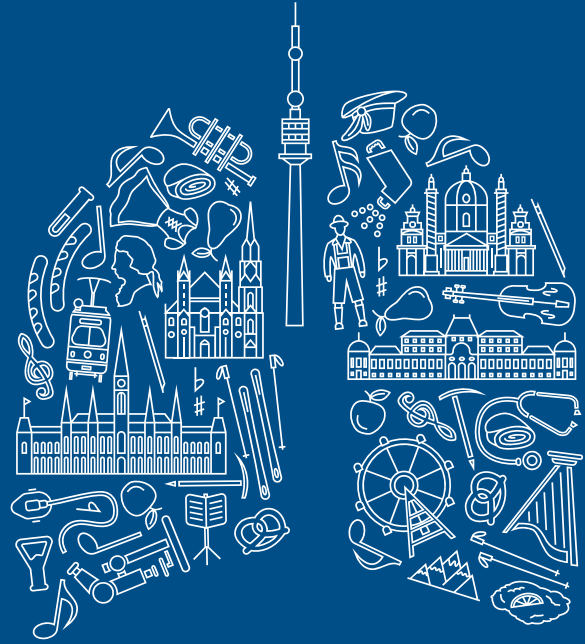

Oliver Heinke

Interplan – Exhibition Partner

**INTERNATIONAL
CONGRESS 2020**

VIENNA Austria, 5-9 September



Contacts:

Exhibition Sales / Space Allocations / Stand project approval

Exhibition Sales / Stand project approvals:

ERS/Kristof Kemp: kristof.kemp@ersnet.org

Technical Exhibition organisation / coordination

Interplan/Oliver Heinke: o.heinke@interplan.de

Industry Meeting Rooms / Lounges

Interplan/Lisanne Leonhardt: l.leonhardt@interplan.de

Exhibitor Registration / Exhibitor Guide Entries

Interplan/Louisa Graf: louisa.graf@interplan.de

Delivery Logistics / Storage / Customs / Delivery time slots

DB Schenker/ Maximilian Herpich: maximilian.herpich@dbschenker.com

Exhibition layout

Contacts Reed Messe Vienna:

Site visits:

karin.katlein@messecongress.at

Service Orders / Online shop

StandOut: sandra.hittinger@standout.eu

Rigging projects / suspension points

Martin.ortner@standout.eu

Catering (exclusive):

Frau Rita Neunteufl

messe@gerstner.at

+43 676 849 516 426

Kapsch / Internet, WiFi

Willibald.jeckel@kapsch.net

Steiner / AV:

STEINERlive.com

+43 2262 73333-0



Good to know



Hall properties: Link to virtual tour Hall B:

http://www.messecongress.at/Tour_MesseWien_20170216/MesseWien.html

- 14.000 SQM Space
- Max loads per suspension point: 250kg
check availability / feasibility of your rigging projects early. Information via:
martin.ortner@standout.eu
- Restaurant on level 1 in the middle of the hall => visibility from above, cover your storage rooms!
- No suspension points on spaces underneath Gallery and Restaurant
- Technical supply via floor channels
- No electrical supply from roof
- Minimum width of aisles 2,5m
- Exclusive catering, no external caterer permitted! Own coffee machine, barista is OK.
- **Traffic Ban for trucks Saturday 15:00 – Monday 05:00**
- No parking spaces for trucks, next spaces are at Simmering or alberner Hafen





Construction rules

Heights:

2,5m at the edge

4,5m if 50cm inside the stand

6m: unbranded / uncladded riggings for technical use only

Transparency:

As open as possible!

Not more than 70% of the view from one side to the other should be blocked.

Depth of hanging banners going around the stand max. 1m.

Banners facing direct neighbors shall not be branded.

Rear and side walls must be completely closed, white, uncabled and clean on the sides facing neighbors.



Stand approval procedure

1. Hand in your project to Kristof Kemp until 03 July
2. Kristof Kemp/Oliver Heinke will check ERS construction / design rule compliance
3. If OK we send official approval email

Attention! ERS does not check compliance with the Reed Messe Vienna construction rules. Make sure to read their regulations (available on the Exhibitor Service Center) thoroughly and plan accordingly!

Certificates validating fire proofness of construction materials are necessary and will be controlled during set-up! For complex rigging structures with many motors and heavy weights we strongly recommend to appoint a structural engineer.

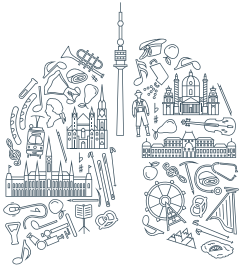

Industry meeting rooms / Lounge / Suite

Approx. 20 rooms with

- 10 – 20 seats, boardroom
- 46 LCD screen
- catering table, wardrobe, waste bin, electricity, power triple sockets, carpet, cleaning
- 2 x Exhibitor Lounges, empty, incl. power, to be equipped by the booking company.

Contact:

Lisanne Leonhardt, l.leonhardt@interplan.de

Meeting rooms in Gallery about the Exhibition

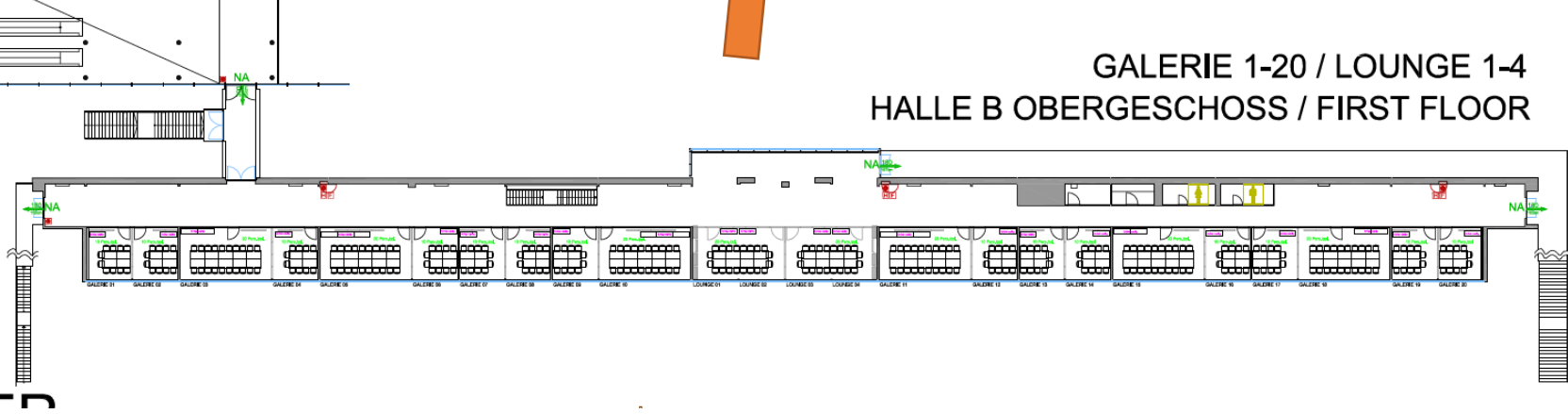

VIP Lounge Hall C to be equipped by exhibitor

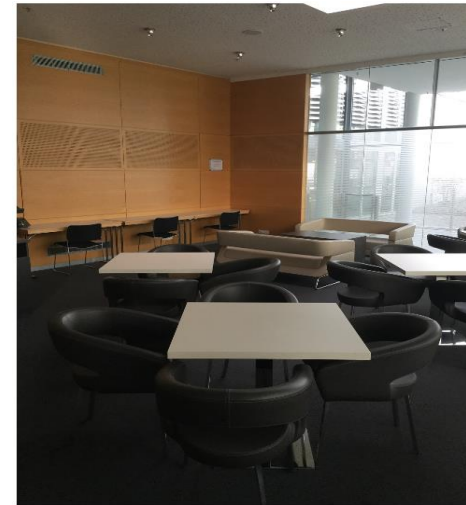
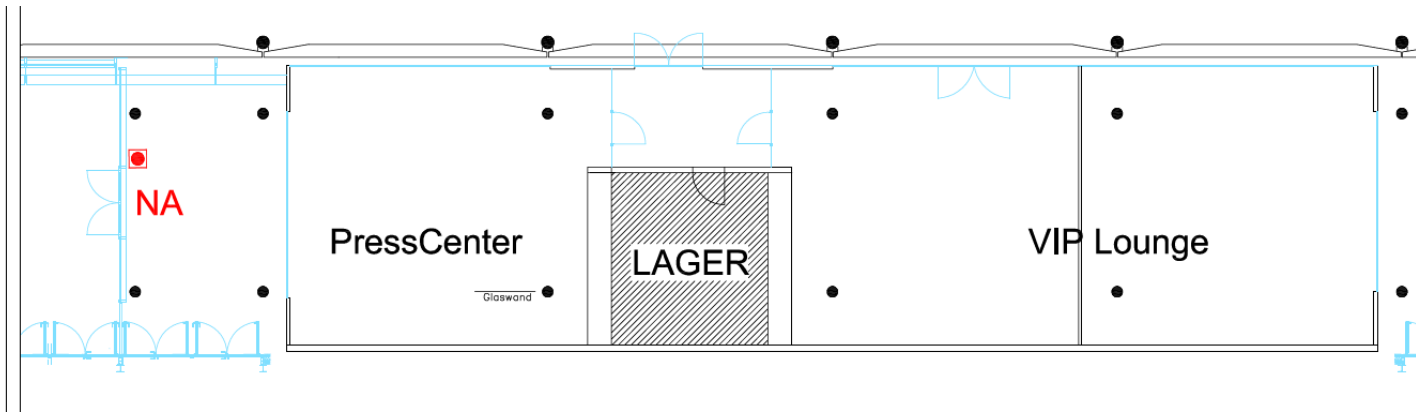

VIP Lounge Hall D example layout to be equipped by exhibitor

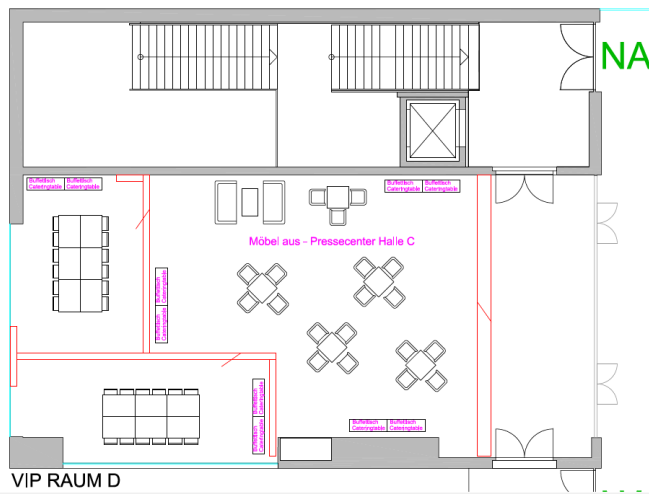

Exhibition badges



Contact: Louisa Graf,
louisa.graf@interplan.de

Registration webpage will be
circulated in May 2020

Additional badges – 10€
After deadline – 35 €

Deadline: 31 July 2020

Any person in the exhibition
requires a badge incl. hostesses,
baristas etc.!

Stand size

Complimentary exhibitor badge allocation

9 – 12 m²

10

13 – 36 m²

14

37 – 60 m²

18

61 – 100 m²

22

101 – 150 m²

32

151 – 200 m²

41

201 – 300 m²

52

over 301 m²

62



Deadlines

Timeline / Schedule:

- **Today ongoing:** Space allocation, contracts, invoices
- **February 2020:** Exhibitor Service Center and StandOut online shop will go live
- **19 June 2020** - Deadline for exhibitors' company profiles for publishing in the Congress App (including co-exhibitors) to be sent via the entry mask on the ESC
- **03 July 2020** - Deadline for confirmation of individual stand designs via Kristof.Kemp@ersnet.org
- **31 July 2020** - Deadline online registration for exhibitor badges
- **5 August 2019** - Deadline for service orders (afterwards 25% surcharge and not everything can be guaranteed)

Subject to change, detailed times will be communicated on the ESC in February



Exhibition times

Set-up:

- 03 – 05 Sep. 2020 - 08:00 – 22:00
Extra set-up days, 01 - 02 Sep. (2.800 € bookable via Interplan)

Night set-up is possible on request 300€ / hour

- 06 Sep – 09 Sep – Exhibition open: 09:00 – 17:00

Dismantling

- 09 Sep (14:00 – 22:00) – 10 Sep (08:00 – 22:00)

Subject to change, detailed times will be communicated on the ESC in February



Alfred Kerschenbauer

Austropa Interconvention - Housing partner

INTERNATIONAL CONGRESS 2020

VIENNA Austria, 5-9 September

Rooms blocked

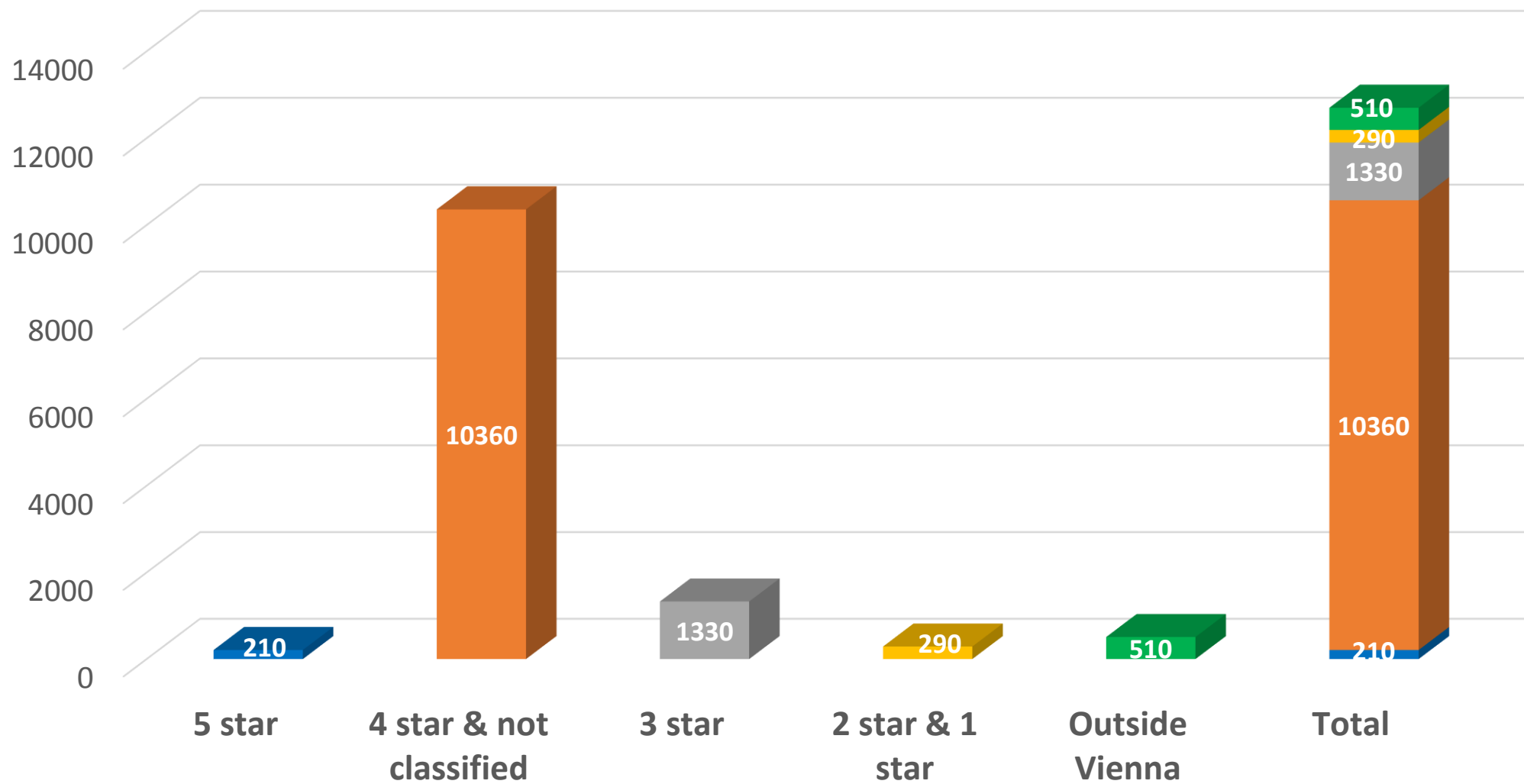



12,700 rooms blocked

3,590 rooms sold



210 rooms



10,360 rooms



1,330 rooms



290 rooms

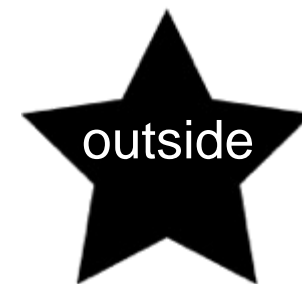

510 rooms

Booking process / website



Verkehrsbüro
MICE Services



ERS 2020 | HOTEL MAP | HOTEL OVERVIEW | CONTACT | BOOKING | SCAM ALERT | VIENNA INFO

Verkehrsbüro
MICE Services



ERS 2020 | HOTEL MAP | HOTEL OVERVIEW | CONTACT | BOOKING | SCAM ALERT | VIENNA INFO

ERS 2020

REED MESSE WIEN – SEPTEMBER 04 – 09, 2020

Austropa Interconvention, Verkehrsbüro MICE Services, is the **official appointed housing office** and has made a pre-selection of centrally located hotels close to the conference venue at best possible rates.

CONFERENCE VENUE – REED MESSE WIEN

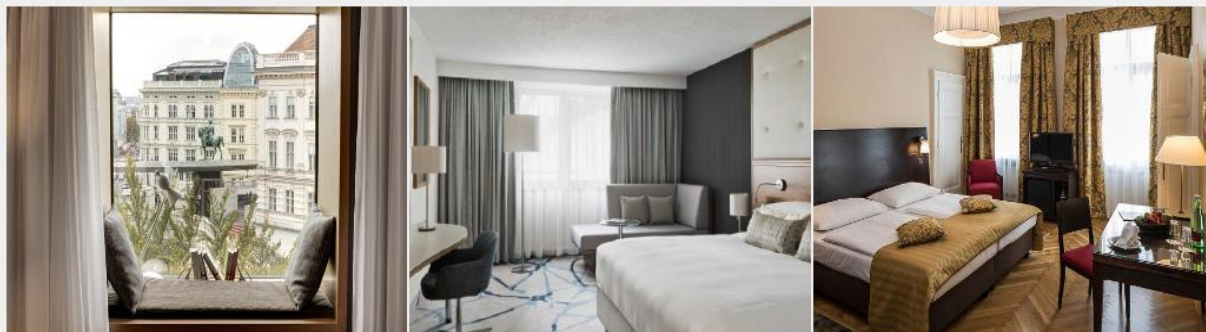

DOWNLOAD
HOTEL LIST AS PDF

INDIVIDUAL BOOKING
(up to 4 rooms)

GROUP REQUEST
(from 5 rooms)

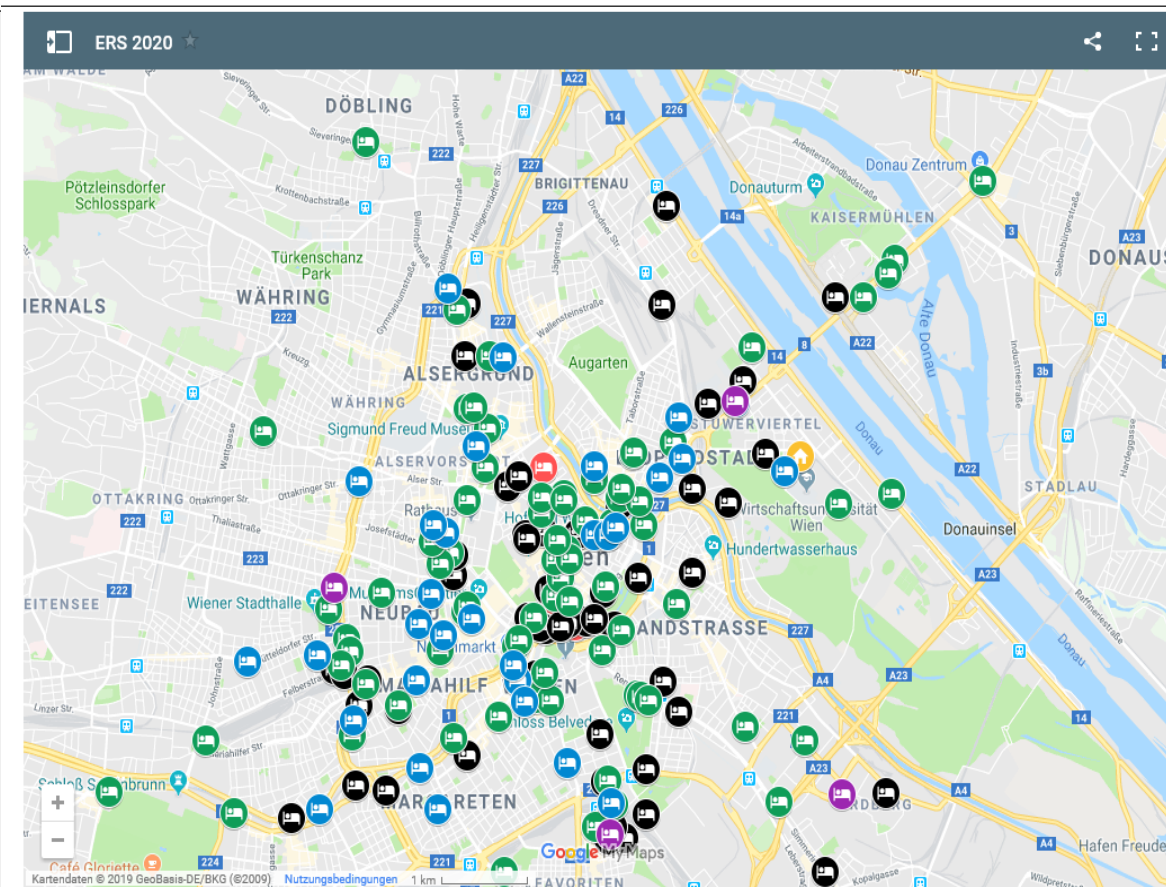

Booking process / website



Verkehrsbüro
MICE Services



HOTEL BOOKING REQUEST FORM (Groups)

Austropa Interconvention - Verkehrsbüro MICE Services is the official housing office for the 30th ERS 2020 in Vienna and has negotiated best possible **congress rates incl. breakfast**. Please choose below your preferred hotel and the requested check in and check out dates. After the receipt of the filled form we will send you an offer within the next days.

HOTEL INFORMATION

(for further hotel information please click here)

Hotel 1st Preference

Please select*

Hotel 2nd Preference

Please select*

Hotel 3rd Preference

Please select*

Preferred Price Range ⓘ

- Euro 90,00 - 150,00
- Euro 150,00 - 200,00
- Euro 200,00 - 270,00
- Euro 270,00 - 350,00
- Euro 350,00 upwards

Hotel Category Preference

- Hotels ** / Budget
- Hotels *** / Standard
- Hotels **** / First Class
- Hotels ***** or Not classified / Premium

Number of rooms

Number of Single rooms*

Number of Double rooms



Arrival Date

Please select*

Departure Date

Please select*

In case that you would like to arrive earlier and/or depart later than the official room allotment is pre-reserved we kindly would ask you to select the available dates and remark your preferred check-in and/or check-out date under the field "special requirements."

Special requirements

ADD BOOKINGS WITH DIFFERENT DATES



Verkehrsbüro MICE Services, Verkehrsbüro Business Travel GmbH, Lassallestrasse 3, 1020 Vienna
Tel.: 0043-1-588 00 510 Fax: 0043-1-588 00 520, e-mail: ers2020hotel@vb-mice.at



Vienna accommodation hotel zones

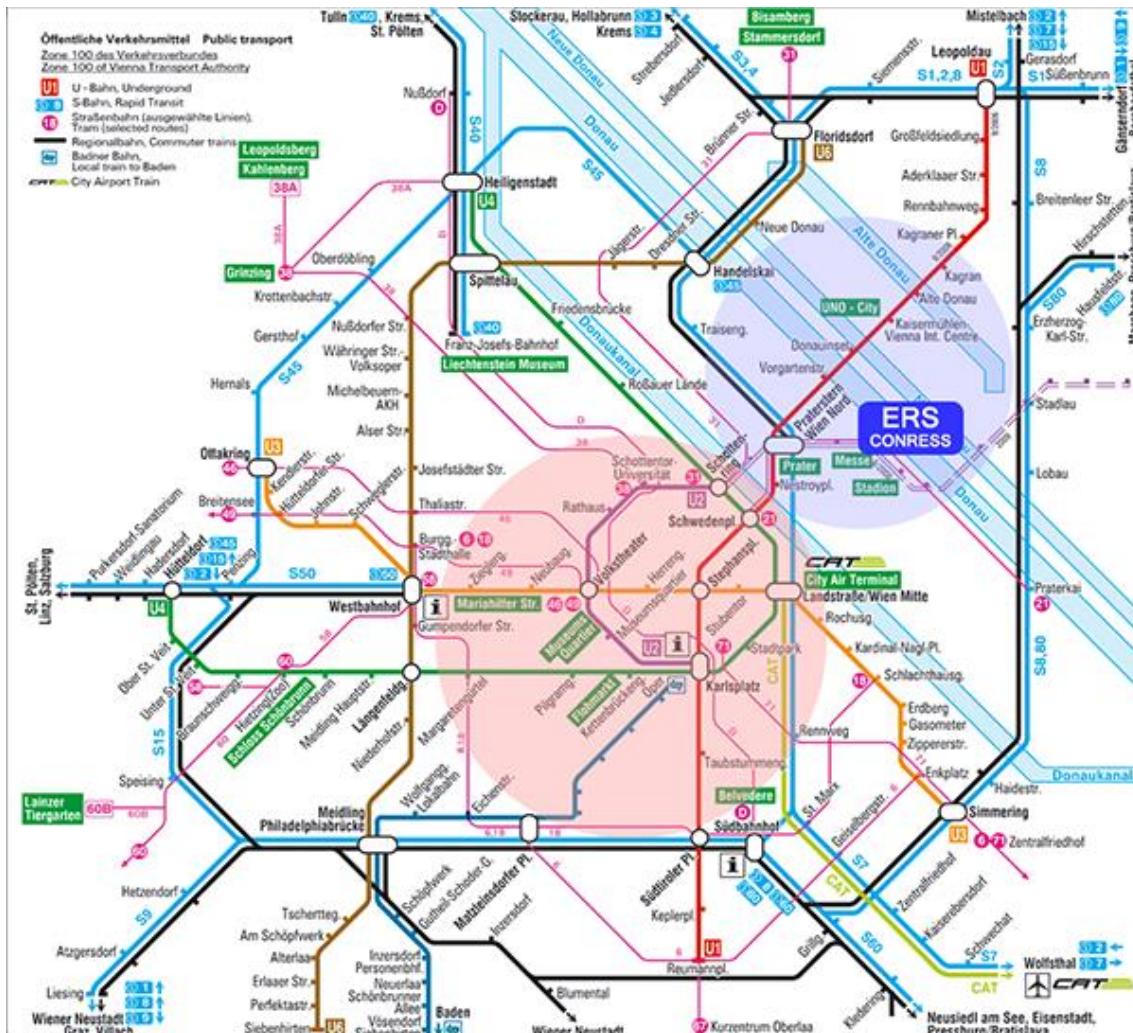

Rooms blocked: 12'700

 **City Center** 10 – 30 min distance from VENUE / 6600 Rooms

 **Close to Venue** 10 – 15 min distance from VENUE / 2110 Rooms incl. 550 rooms walking distance

 **Rest of the City** 20 – 40 min distance from VENUE / 3480 Rooms

Outside of Vienna 40+ min distance from VENUE / 510 Rooms

**times are approximate and by public transportation*

Public transportation card



**5 DAYS
CARDS**

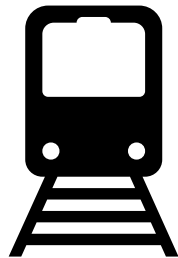

- **Transportation cards will be sold to Participants at € 17.92.- (pricing 2018 – New pricing to be advised)**
- **Validity 05 to 09 September 2020**
- The card allows unlimited rides within the Vienna Center on overground and underground urban lines during the days of validity, which includes: metro, urban bus, urban railways and tram lines.

The above includes:

- Unlimited travel within Vienna city center
- Not valid for the Airport buses and the City Airport Train (CAT)



Getting around the city

- Vienna offers one of the most modern and efficient public transport systems worldwide
- 5 underground lines, 2 stops directly at congress venue
- 28 tram routes
- 90 bus routes & 23 night buses
- 24 hour underground service on weekends



Contacts housing services



Daniela Filzwieser & Sandrina Sinko

ers2020hotel@vb-mice.at



Delegates Feedback

Werner Bill

INTERNATIONAL CONGRESS 2020

VIENNA Austria, 5-9 September

Profiles of our delegates

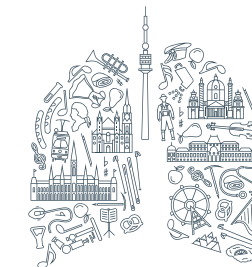

MAIN PROFESSION OF PARTICIPANTS

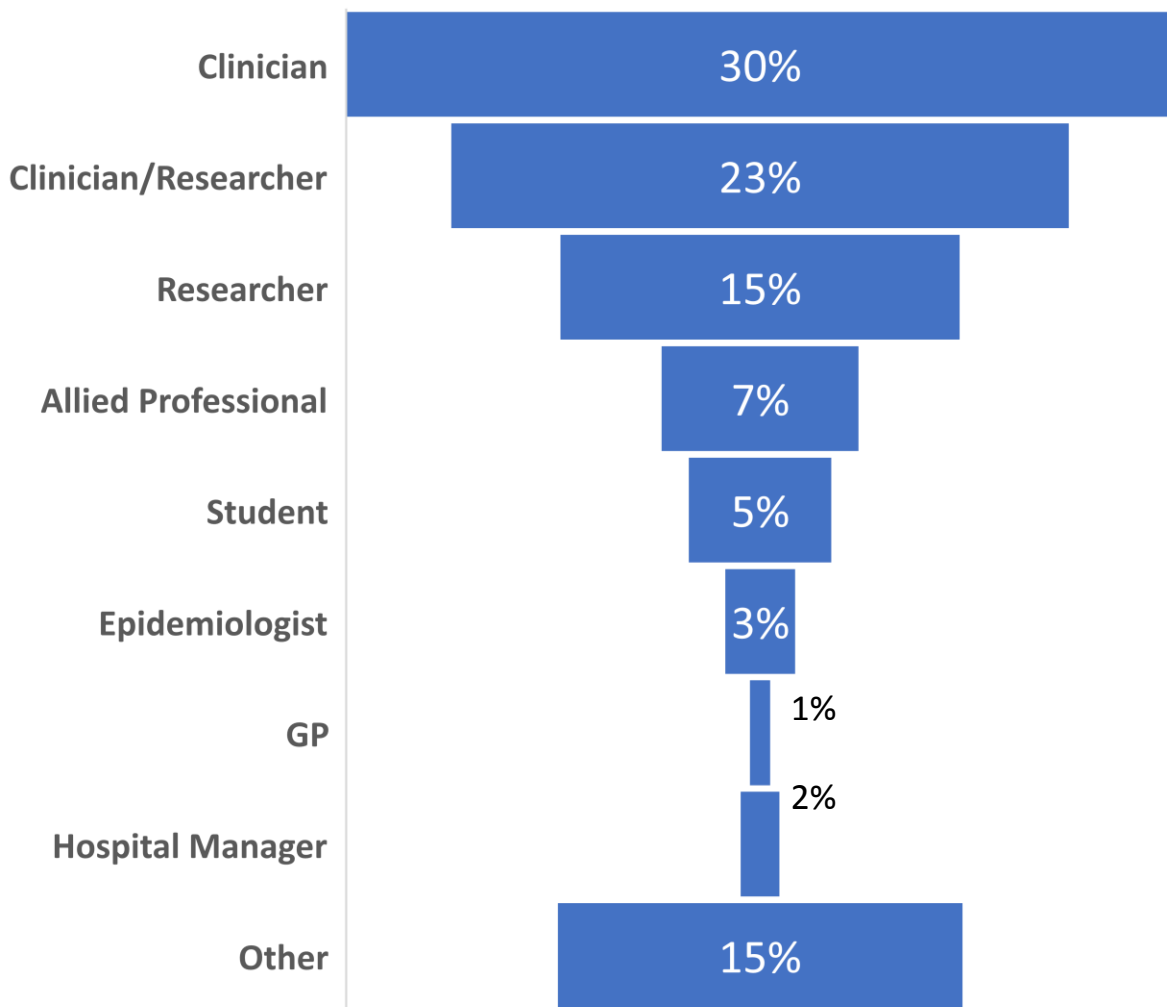

MAIN INTEREST OF

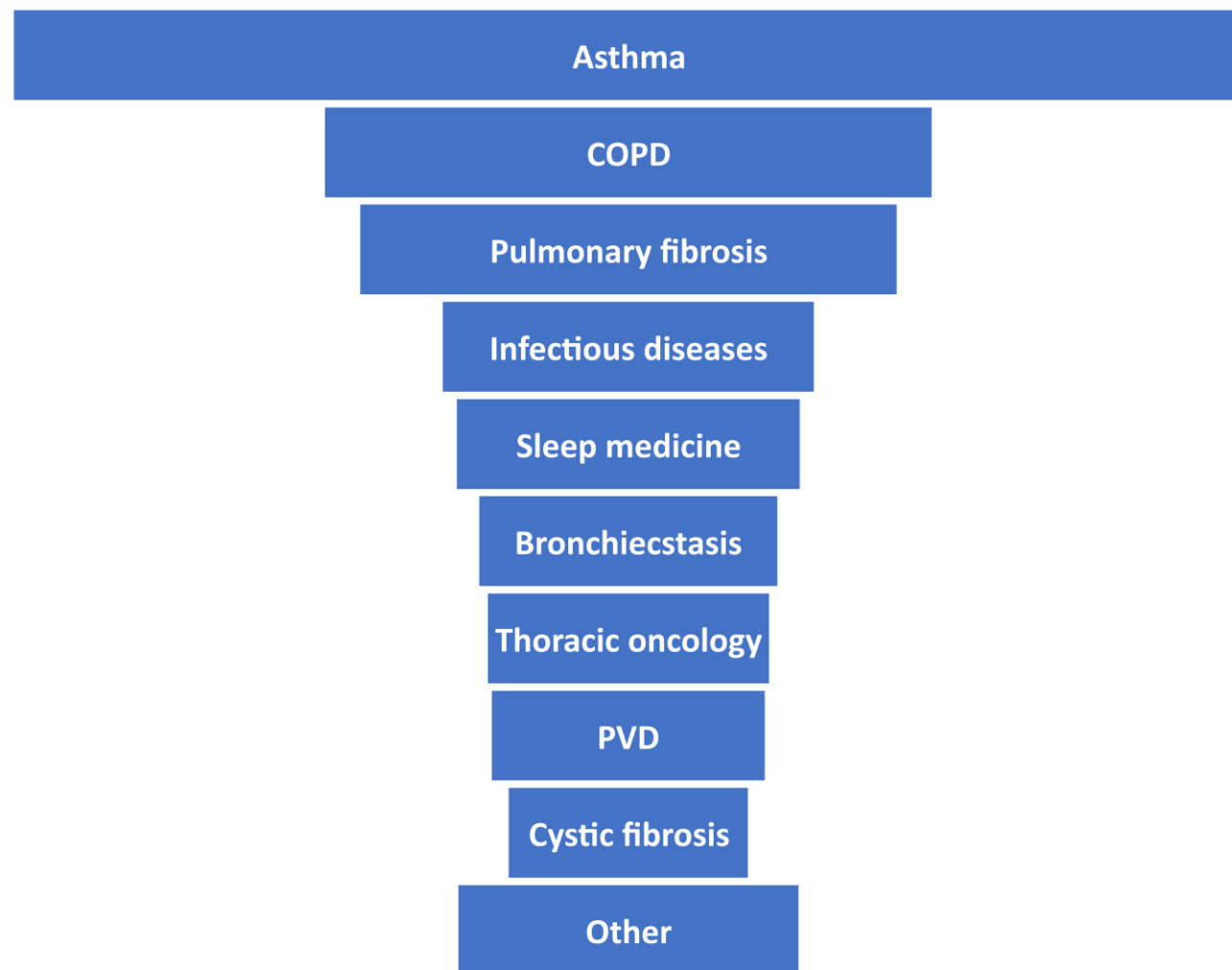

Main reasons for attending the ERS Congress



MAIN REASONS FOR PARTICIPATING

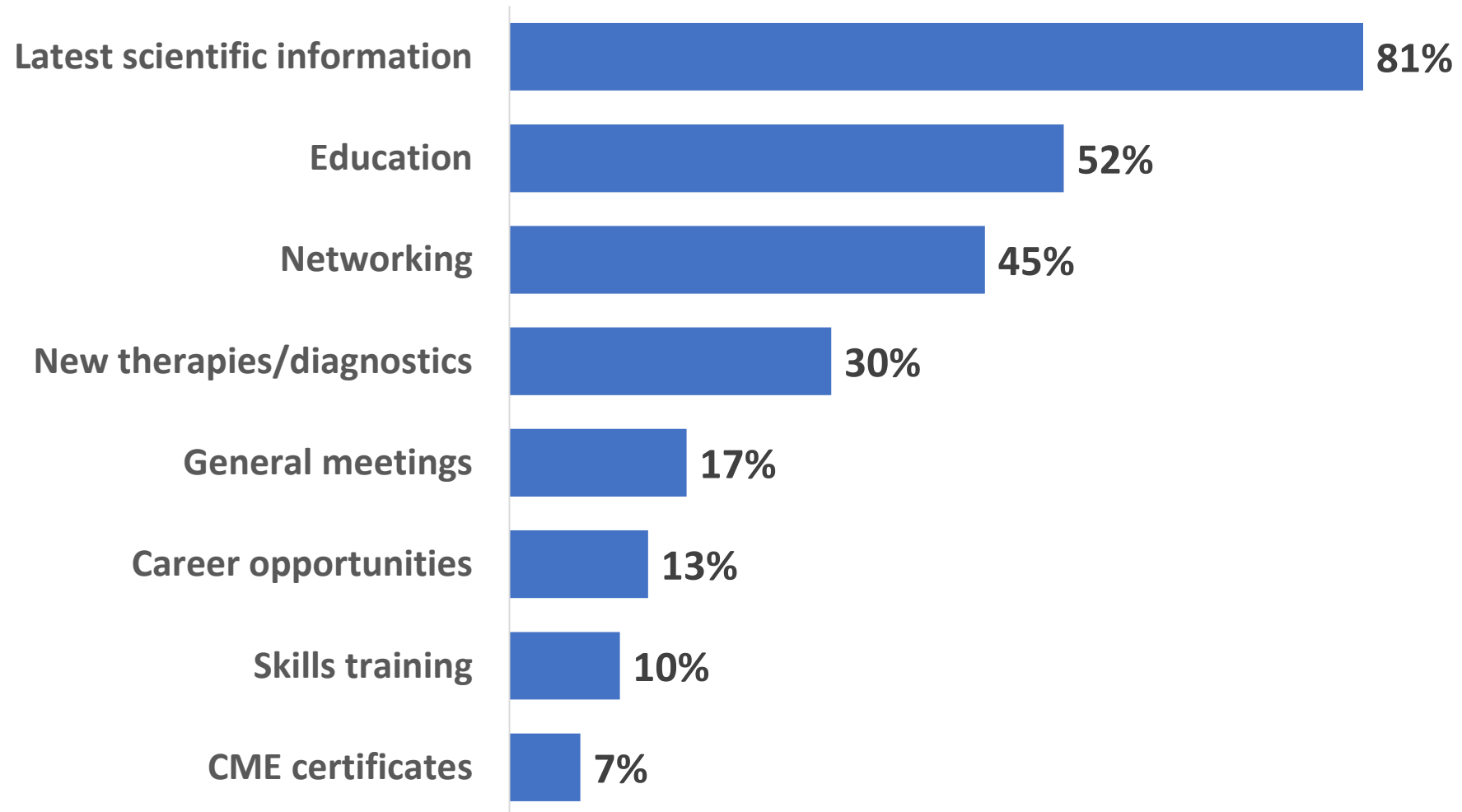

Structure of a delegate's day

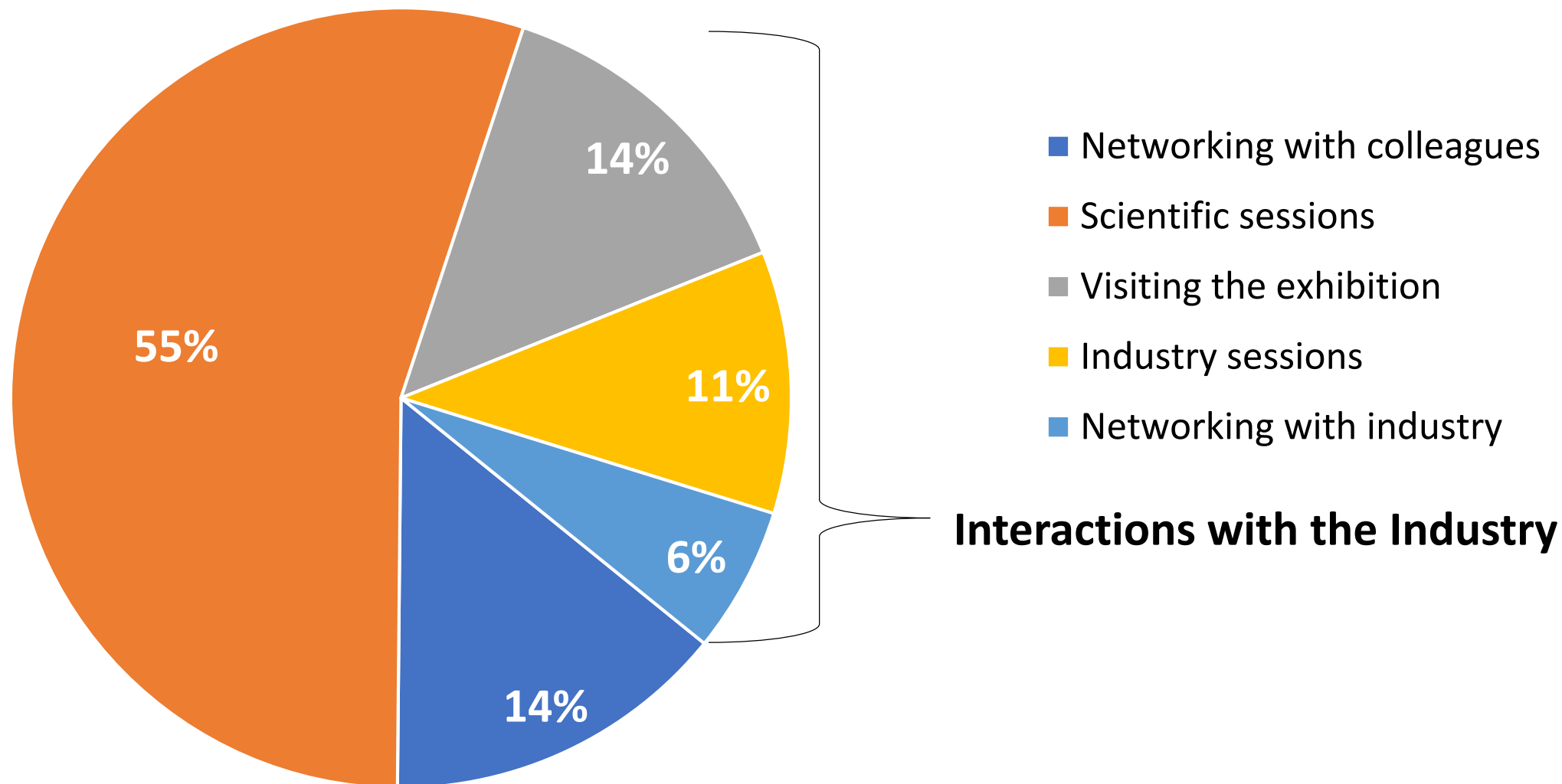

Use of Congress material after Congress

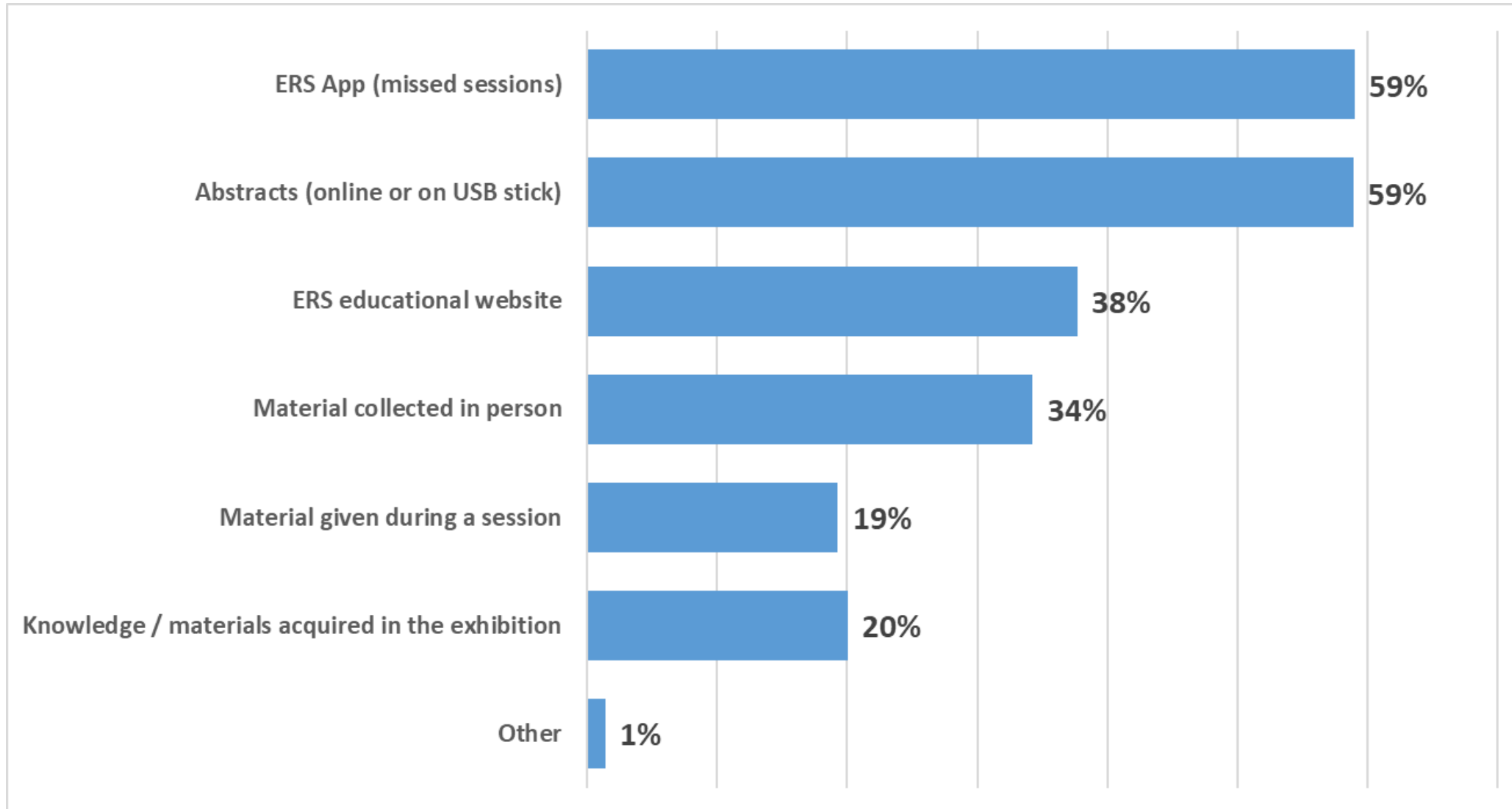

Several answers possible



Most interesting parts of the Congress

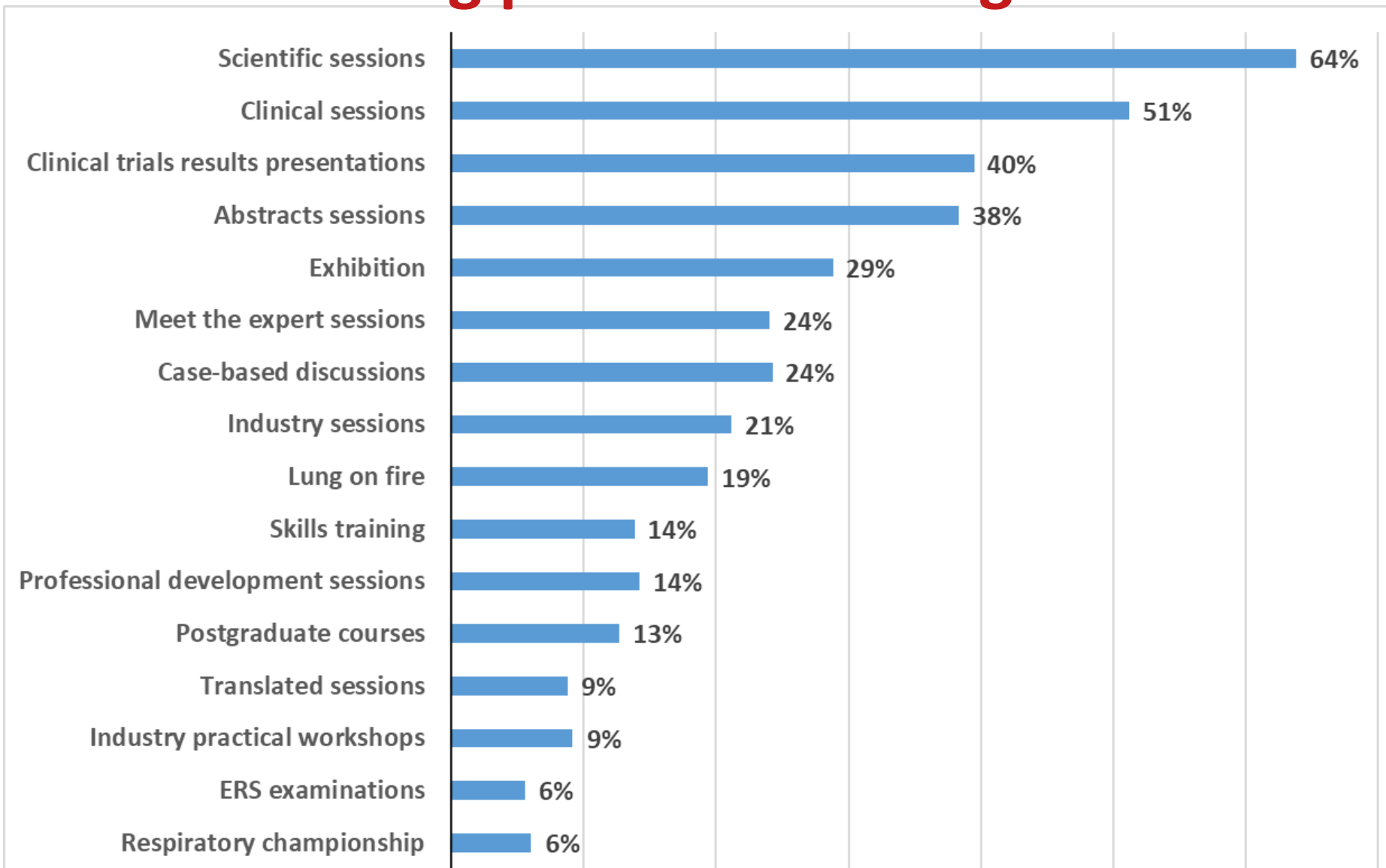

Several answers possible

Have you visited the Exhibition?

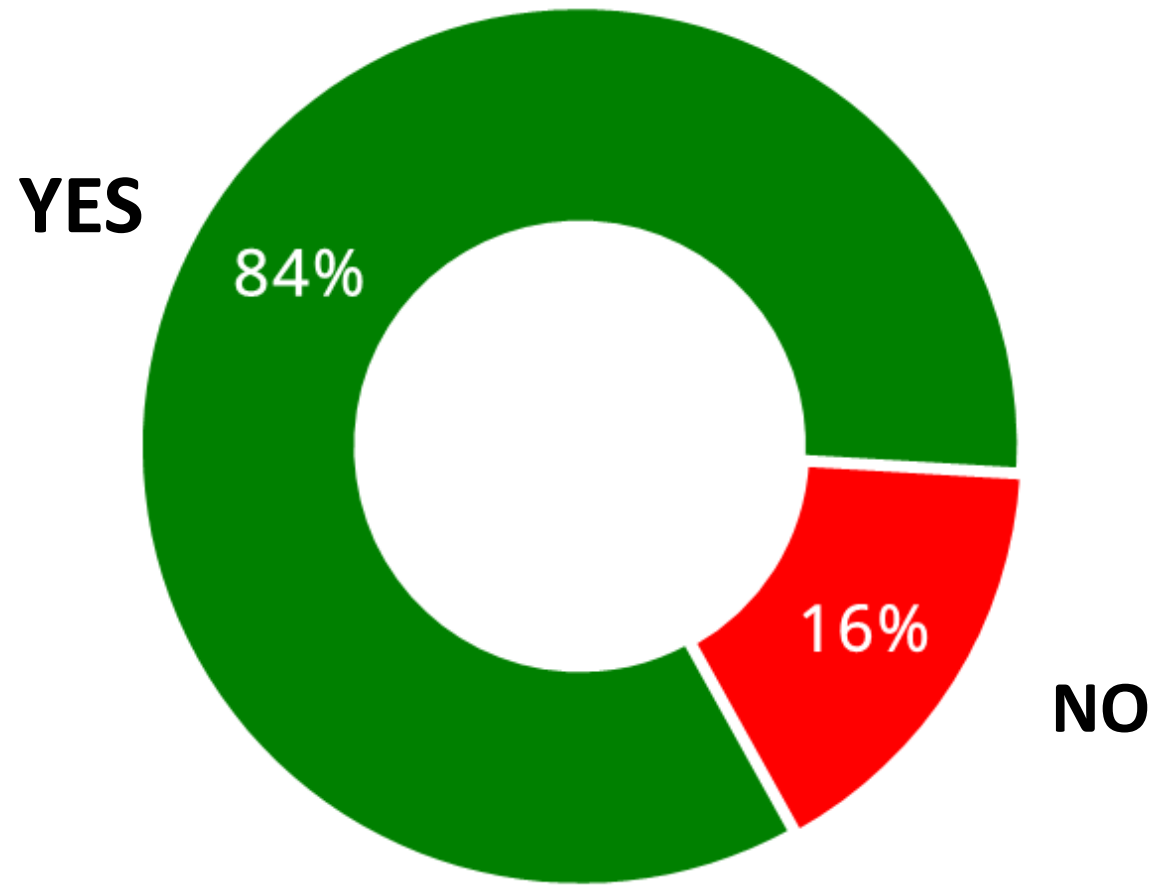

Time spent in the Exhibition



75% of the delegates spent more than 2 hours

50% of the delegates spent more than 3 hours

What I have learned in the Exhibition will lead me to...

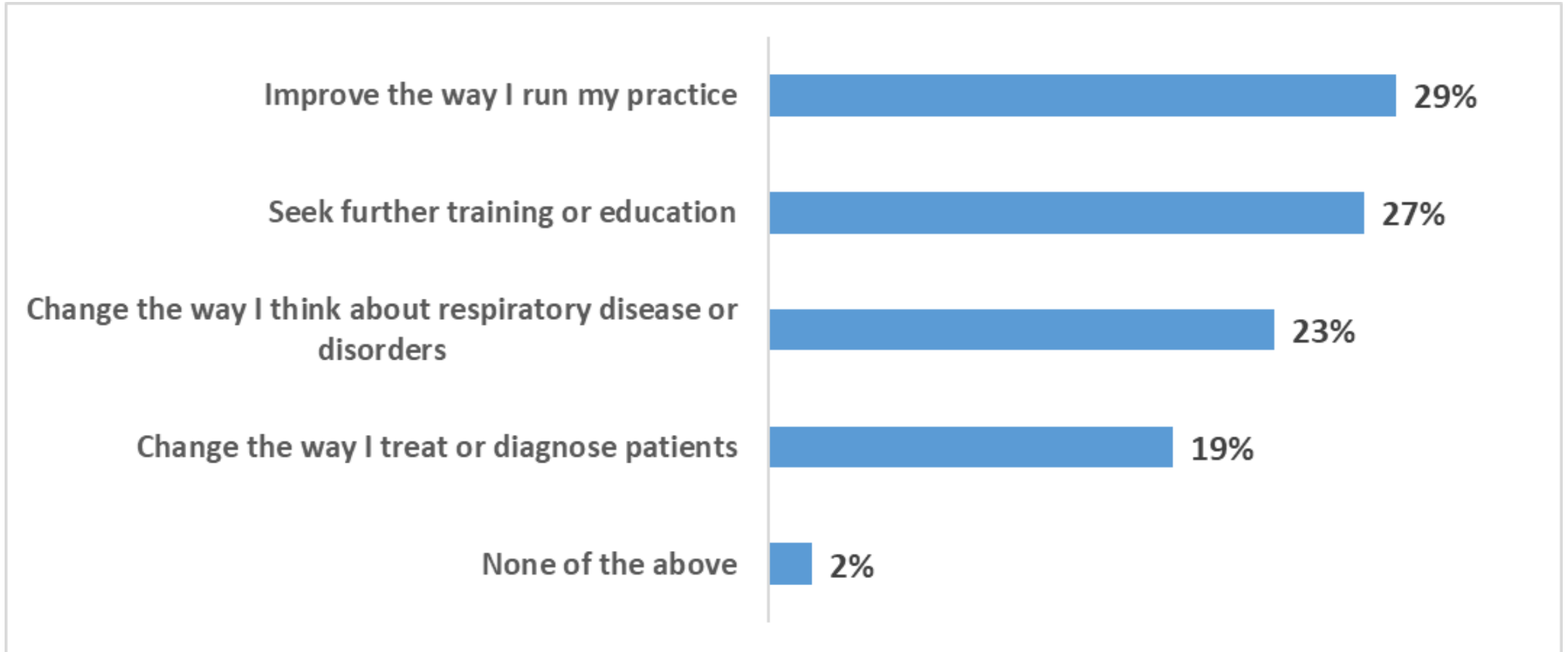

Funding of delegates

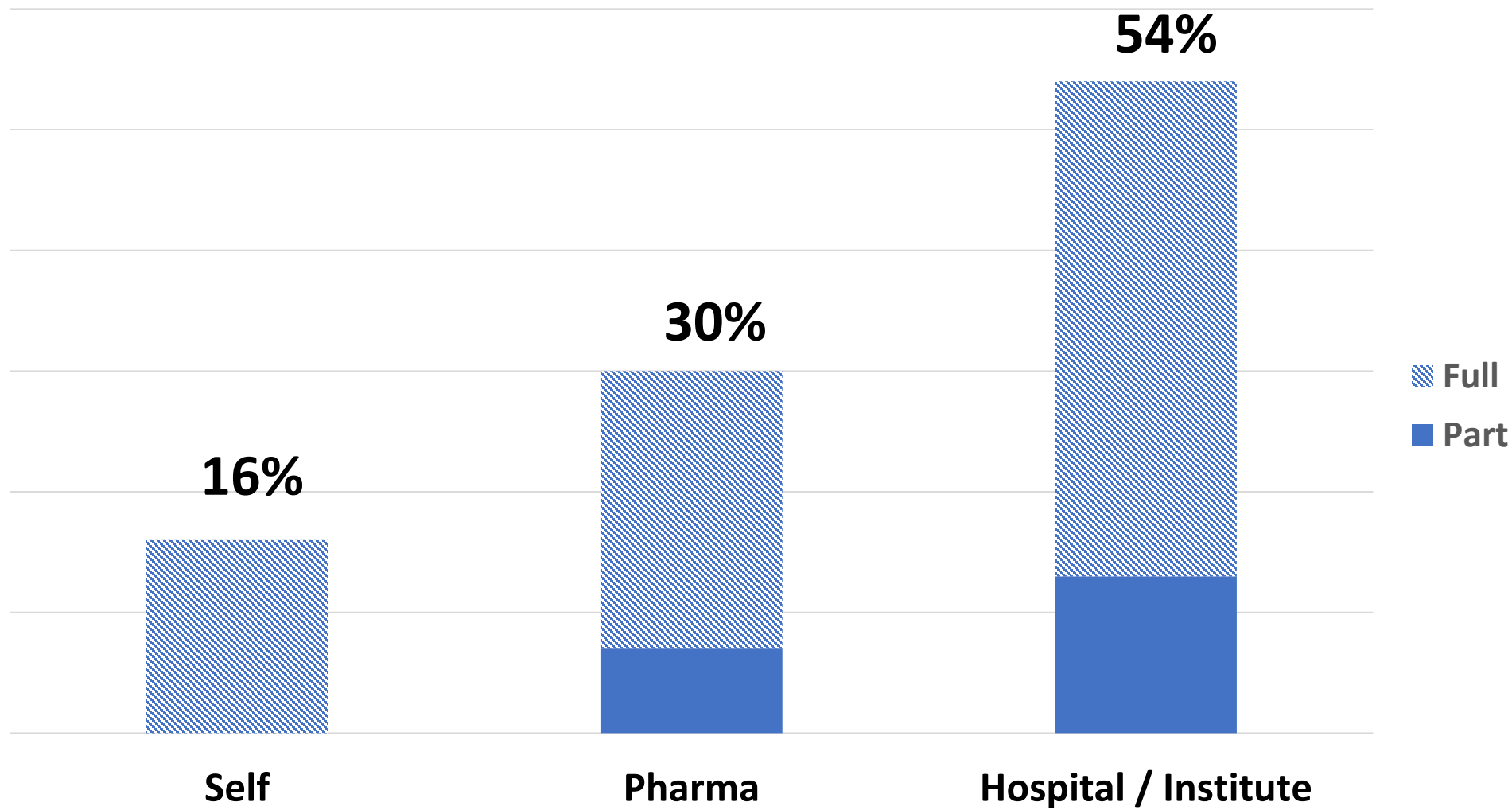



Most impressive and memorable stands

Delegates' perspectives

Top 5 – Pharma companies	Top 5 – Device companies
GSK	Philips
AstraZeneca	Olympus
TEVA	PulmonX
Chiesi	Breas
Boehringer Ingelheim	POWERbreathe

Most highly rated stands

Experts' perspectives



Top 5 – Pharma companies	Top 5 – Devices companies
GSK	Philips
Boehringer Ingelheim	Olympus
TEVA	Broncus Medical
AstraZeneca	ResMed
Mundipharma	Cepheid



INTERNATIONAL CONGRESS 2020

VIENNA Austria, 5-9 September

Tour of the venue

Group A – K. Kemp

Group B – P. Foo & N. Luginbuhl

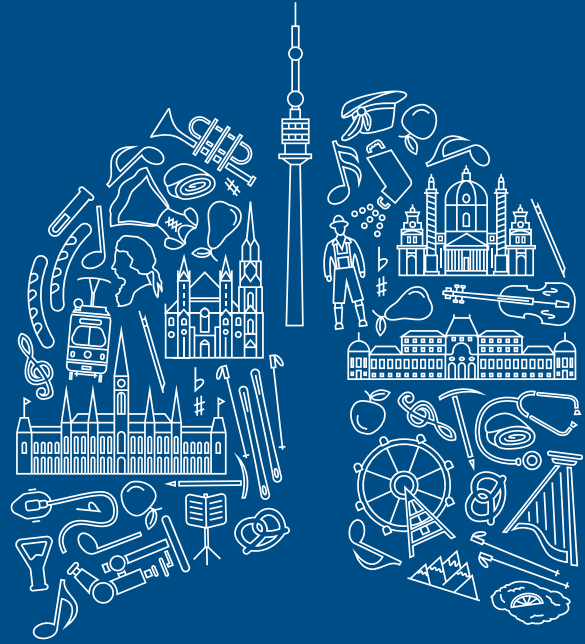

Industry Feedback

Kristof Kemp

INTERNATIONAL CONGRESS 2020

VIENNA Austria, 5-9 September

Evaluation of suppliers & partners

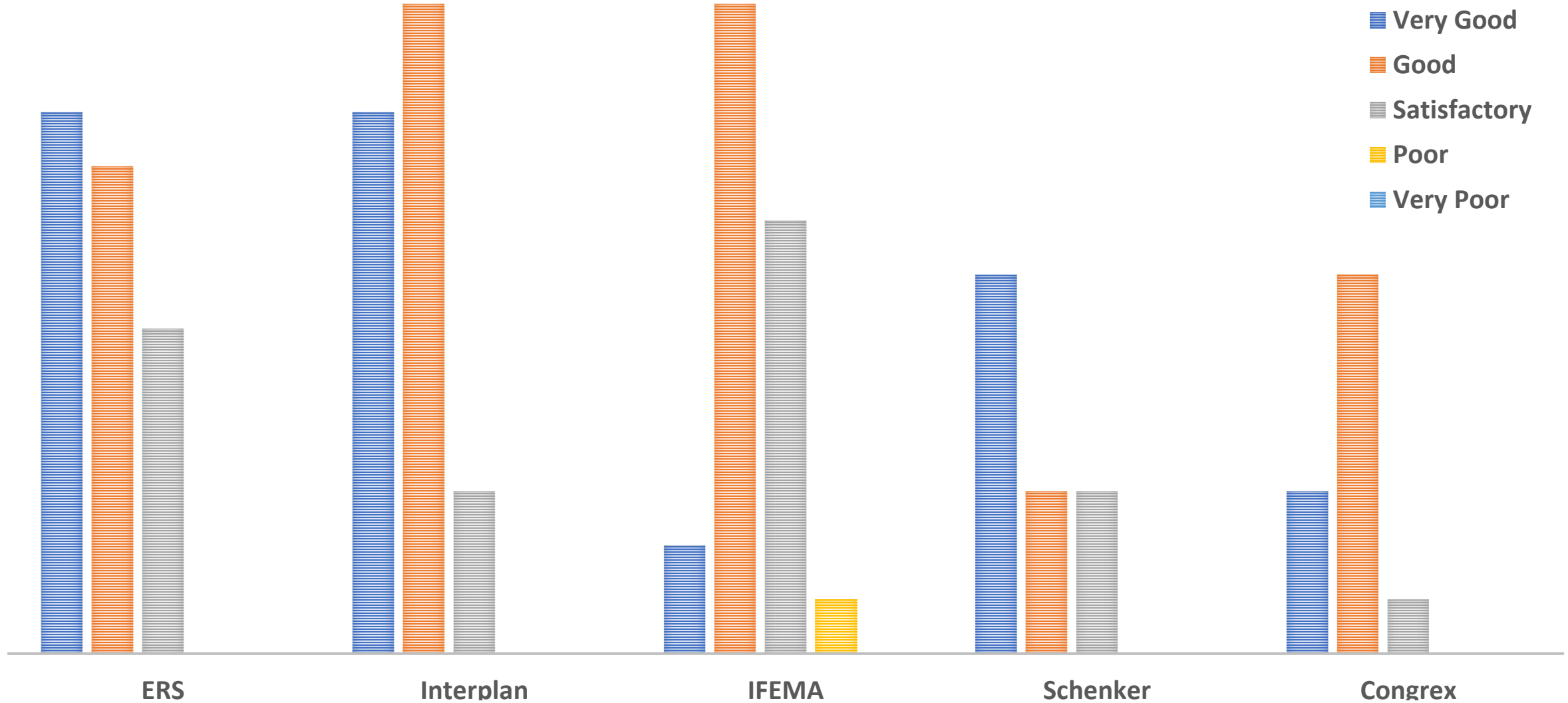

Outstanding & recurring comments from the Exhibition survey



- **Scanners did not work properly or were too slow (camera not focusing with the dim lights)**
- **Pulmonary Pavilion was a good initiative but needs more advertising**
- **One webshop grouping all services for the industry – unique contact**
- **Plastic used by venue / ERS should be as involved with the Venue as they are with their own sustainability.**
- **Poor Carpet (set-up done with carpet..)**

Outstanding & recurring comments from the Industry sessions' survey

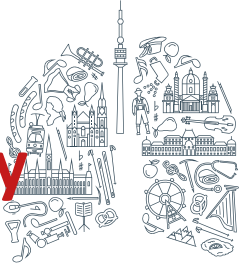

- **Language issue with the technicians**
- **Work with one supplier for Symposia rather than 2 or 3**
- **Sound proofing in Hall 6 was very poor**
- **Poor badge scanners (3-5 seconds to scan)**
- **Stages did not look as professional as in previous years**

ERS Marketing & Corporate Relations contacts



Steve Sealy

Associate Director

E-mail: steve.sealy@ersnet.org

Tel: +41 21 213 0161

Alexandre Delage

Corporate Funding Manager

E-mail: alexandre.delage@ersnet.org

Tel: +41 21 213 0123

Kristof Kemp

Congress Industry Relations Manager

E-mail: kristof.kemp@ersnet.org

Tel: +41 21 213 0164

Nicolas Luginbühl

Industry Practical Workshops / Advertising / Sponsorships

E-mail: Nicolas.luginbuhl@ersnet.org

Tel: +41 21 213 0165

Fanny-Anh Le Hoang

Industry Symposia

E-mail: fanny-anh.lehoang@ersnet.org

Tel: +41 21 213 0163

Gergana Yaneva

Industry Finance

E-mail: gergana.yaneva@ersnet.org

Tel: +41 21 213 0167



Site Visit Q&A

INTERNATIONAL CONGRESS 2020

VIENNA Austria, 5-9 September



INTERNATIONAL CONGRESS 2020

VIENNA Austria, 5-9 September

ERS International Congress 2021

Barcelona

Dates: 04-08 September 2021

Venue: FIRA Barcelona Gran Via

Housing PCO: B-Network ers2021hotels@bnetwork.com

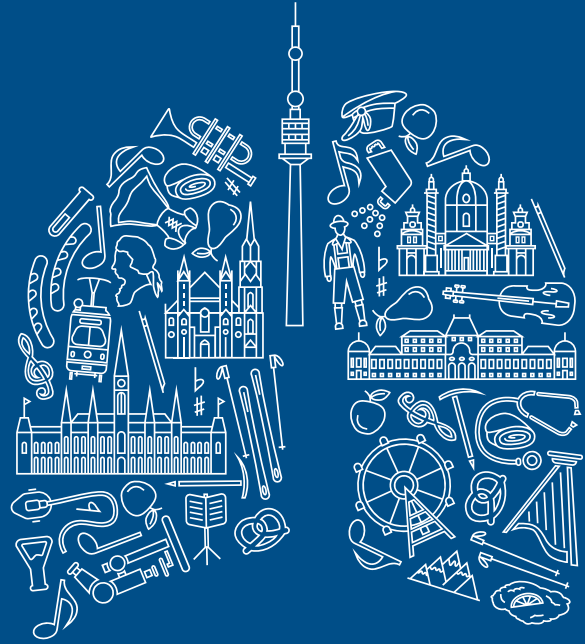

Werner Bill

ERS Executive Director

**INTERNATIONAL
CONGRESS 2020**

VIENNA Austria, 5-9 September



INTERNATIONAL CONGRESS 2020

VIENNA Austria, 5-9 September